



---

# AL13<sup>®</sup> Panel System Installation Guide



Patented



United States Patent  
and Trademark Office



Canadian Intellectual  
Property Office

get more info at [al13.com/patents](http://al13.com/patents)

# 01

---

## Installation Guidelines 1

### **IMPORTANT: Failure to follow the guidelines herein will void the AL13® warranty**

Please read and understand this guide. Any questions or inconsistencies should be directed to [info@al13.ca](mailto:info@al13.ca)

Guidelines may vary depending on project particulars and conditions. Contact AL13® with questions regarding variance from this guide. Standard carpentry skills are required for optimum results. Good health and safety practices must be followed when installing AL13® ACM System. Please refer to the AL13® Material Safety Data Sheets for more info.

---

### **Key steps for a successful installation**

- 01 Understand the various elements of the system
  - 02 Plan the installation, work schedule, layout, and material usage
  - 03 Ensure everyone working has read the installation guidelines
  - 04 Execute work in the sequence set forth in the installation guidelines
  - 05 Protection should be worn; gloves, ear protection, steel toe boots, safety glasses and hard hat
  - 06 Protect the product by storing the material in a dry and clean environment
  - 07 Ensure proper fit of the system
  - 08 Upon completion of installation remove protective film and clean any debris on wall
- 

### **Pre-installation: Receiving materials**

When materials arrive on site, ensure that all panels, extrusions and other component packaging are in good condition, free of any defects, and verify that the materials match the order / shop drawings.

- > Shipping or packaging issues should be noted on the waybill and then reported to the distributor.
- > Should any products be damaged, the receiving party is responsible for filing a freight claim to the shipping company within 24 hours of receiving product.
- > Defective materials should be reported to the distributor from which the product was dispatched from.

# 01







## Installation Guidelines 2

Product Legend: This installation guide will discuss various components of the system and use component reference blocks. Please refer to the following to verify the correct component.

Component	Size / piece	Material
 3mm ACM Panel	4' x 8' sheet	AAMA 2605 coated with PE core or FR core
 4mm ACM Panel	4' x 8' sheet	AAMA 2605 coated with PE core or FR core
 End Frame	8' length	AAMA 2605 coated aluminum extrusion
 Inside Corner	8' length	AAMA 2605 coated aluminum extrusion
 Outside Corner	8' length	AAMA 2605 coated aluminum extrusion
 Half Back Plate	8' length	Anodized aluminum extrusion
 Full Back Plate	8' length	Anodized aluminum extrusion
 Reveal Cap	8' length	AAMA 2605 coated aluminum extrusion
 Perimeter Reveal Cap	8' length	AAMA 2605 coated aluminum extrusion
 Flat Cap	8' length	AAMA 2605 coated aluminum extrusion

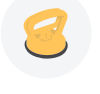

# 01

## Installation Guidelines 3

Component	Size / piece	Material
 Perimeter Flat Cap	8' length	AAMA 2605 coated with PE core or FR core
 I-Beam	8' length	Aluminum Extrusion
 4mm Panel System Clip	box (100)	Fiberglass reinforced plastic
 3mm Panel System Clip	box (100)	Fiberglass reinforced plastic
 Wood Fastener	500/package 1-1/2" long	Wood Substrate: #12 – 14 x 1 1/2" mini drill-point fasteners with EPDM washers and corrosion-resistant coating
 Concrete Fastener	100/package 1-1/4" long	Concrete Walls: #11 x 1 1/4" concrete screw anchor with corrosion-resistant coating.
 Metal Fastener	500/package 3/4" long	Steel Substrate: #10-16 x 3/4" self-drilling, self-tapping screws with corrosion-resistant coating
 Suction Cup	each	coated aluminum

# 01

## Installation Guidelines 4

Component	Size / piece	Material
 80T Non ferrous Saw Blade	10 " - each	carbide tip / high-speed steel
 60T Non ferrous Saw Blade	6-1/4" - each	carbide tip / high-speed steel
 AL13® Gloves	each	rubber / lycra
 Flat SLED	each	plastic and rubber
 Reveal SLED	each	plastic and rubber
 AL13® Tape	108' roll	AL13® double sided acrylic adhesive tape

# 01

---

## Installation Guidelines 5

### Inventory

Once material is verified to be in good condition, take inventory of units according to the packing slip. Make sure all materials - panel, extrusion, fasteners, and adhesive tape - and quantities are present.

*The distributor should be notified immediately if the order has any missing or incomplete components. Failure to do so may void re-fulfillment.*

---

### Material handling

AL13<sup>®</sup> ACM System panels are shipped on pallets in 50 sheets (or less). The sheets are secured in place with metal strapping and covered with protective wrap. Panels should be kept in their original packaging or similar and moved by a forklift or pallet jack.

Once a pallet is unwrapped and metal straps are cut, panels may be moved individually. Ensure to use clean work gloves to protect from sharp edges and keep panels clean. Panels must be first lifted vertically away from panel, then away - DO NOT DRAG OR SLIDE panels.

Store all materials in a clean and dry environment, both before and after materials are unpacked.

Wear gloves when handling materials, and use suction cups when mounting panels to wall. Ensure to wear eye and ear protection when cutting materials. Always wear appropriate personal protective equipment.

---

### Tools

Our Panel System is made to be installed with general tools, a recommended tool list is as follows:

- > Sawhorses/work table
- > Circular saw, handheld with guide
- > Table saw
- > Cordless electric impact with appropriate bits
- > AL13<sup>®</sup> saw blades
- > AL13<sup>®</sup> SLED tool
- > AL13<sup>®</sup> suction cups
- > Jigsaw
- > File (for de-burring cut sheets)
- > Level/plumb line
- > Chalk line
- > Cordless electric drill
- > Drill bit set

# 01

## Installation Guidelines 6

### Panel layout

It is important to commence work with good construction practice and schedule work with other trades to avoid delays. Once installation begins it must not be delayed for any length of time as damage may occur to the system, substrate or both due to exposure to the elements. Before any installation begins, it is imperative to plan the layout of the system. The architectural plans/elevations should be reviewed to determine the appropriate 'grid' for the system. Should no such plans be available, measure areas to develop a pattern that will maximize panel size, aesthetics and minimize fabrication.

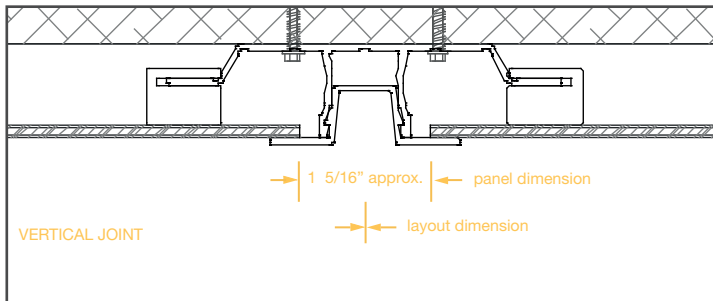

Standard panel size is 4' x 8' (1220mm x 2440mm). Do not use these dimensions for determining layout lines, adequate space must be left between panels for extrusions.

### Material use

Once the layout has been determined, double check that there is an adequate amount of materials present for the application at hand. Since estimation takeoffs and quantities are based on panel layout, any installation varying from the original plan may affect quantities and cause material shortages. Make sure to check the cut plan to determine if this will result in any further shortages. When calculating material usage, note that vertical extrusions - in most cases - will carry through continuously, while the horizontals tuck and terminate under the tabs of the verticals.

# AL13® Panel System.

AL13  
Architectural  
Systems®

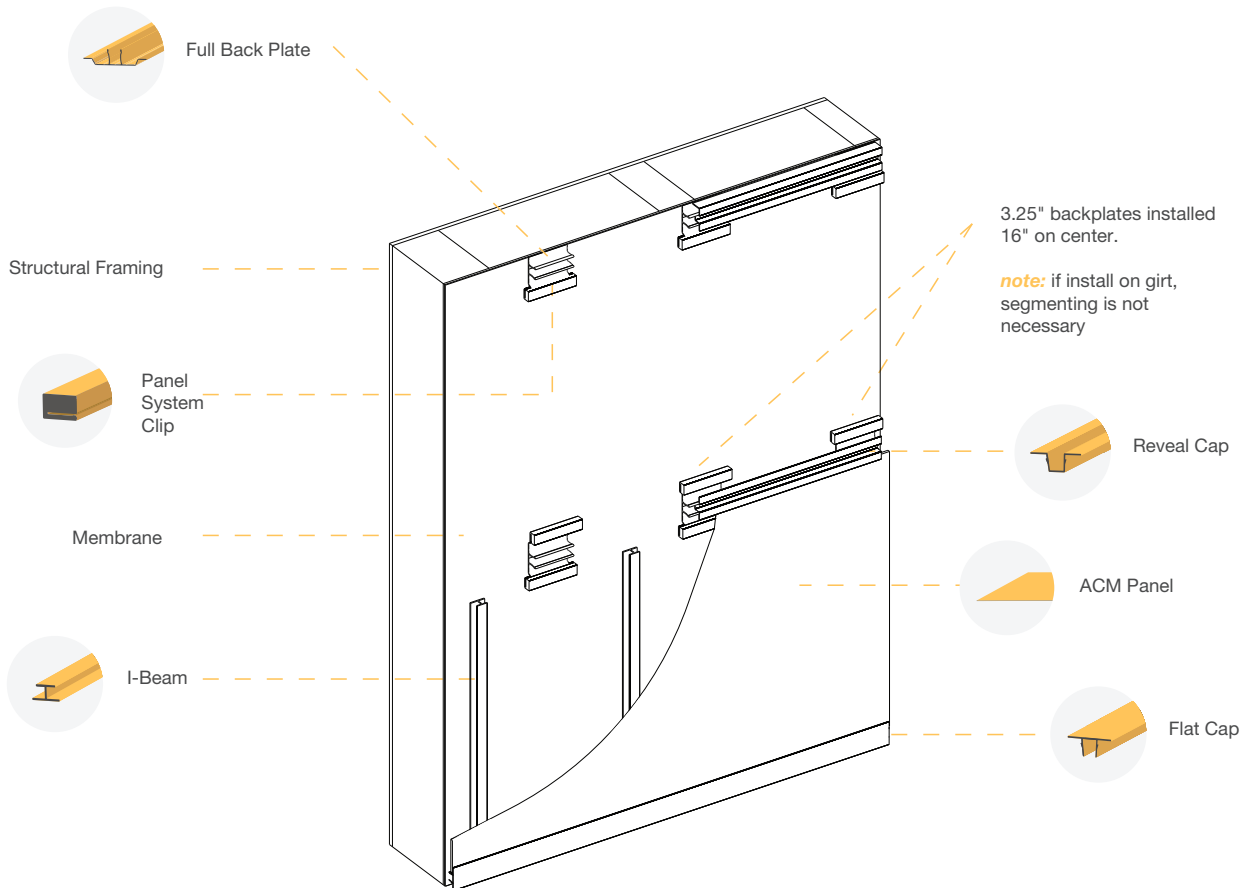

The backplates and various caps use an interference fit and require an impact to engage the two components. Ensure that the substrate is solid enough to sustain this impact.



# 02

---

## Panel Install 01

---

Example wall

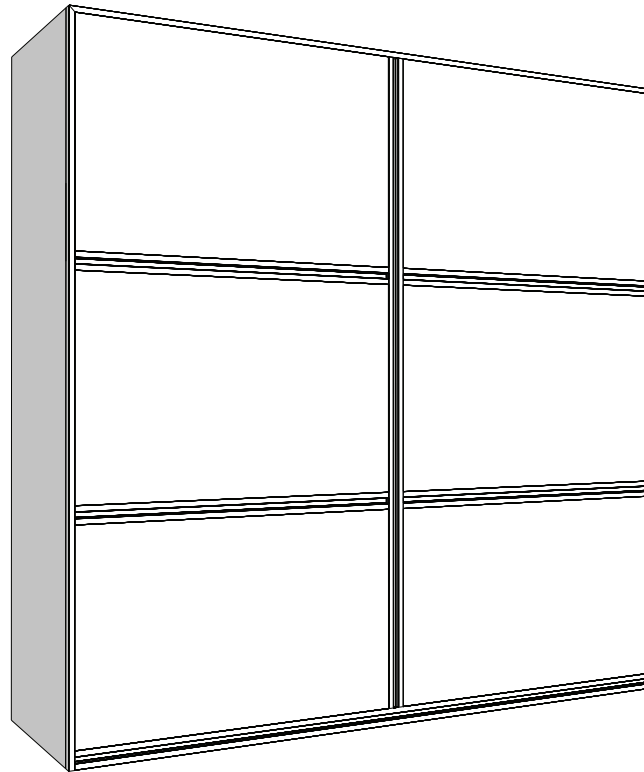

---

The first part of the installation guide outlines a basic install on a flat wall as illustrated above in its completed form. The subsequent sections will outline more intricate details like inside corners, outside corners, windows, doors, overhangs and build-outs. (Please be sure to have read the General Install section first).

---

The building envelope, which includes weather barrier and all applicable flashings, must be completed to local building code before any AL13® component is to be laid-out or installed.

# 02

## Panel Install 02

Laying out the grid

**IMPORTANT!**

Successful install relies on a properly built and prepared substrate - substrate flatness is especially critical.

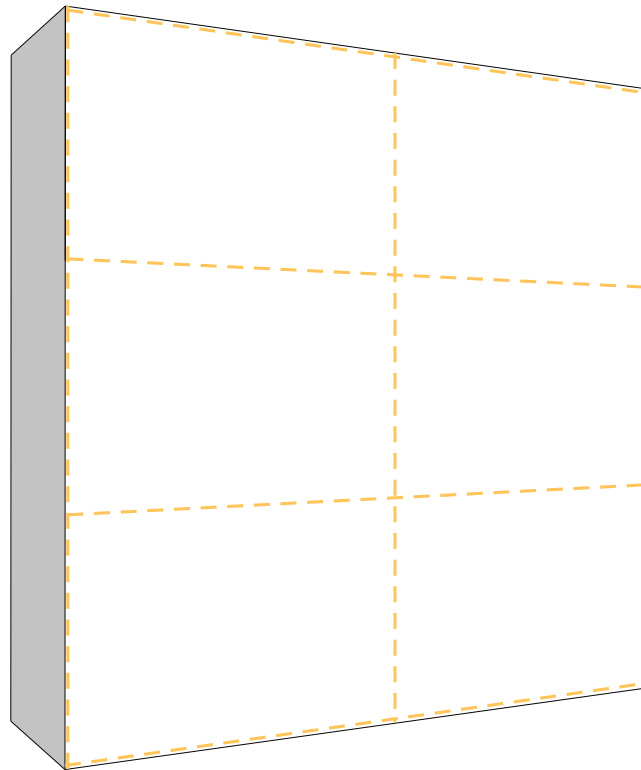

Using the chosen layout, determine the best suited datum - or starting point - shown here as the lower left corner. Lay out the panel grid using chalk lines (or similar) from the datum point, ensuring that all lines are plumb and level. These lines are to indicate the locations of the extruded frame components that will secure and frame the ACM panel.

# 02

## Panel Install 03

Fasten vertical perimeter extrusions

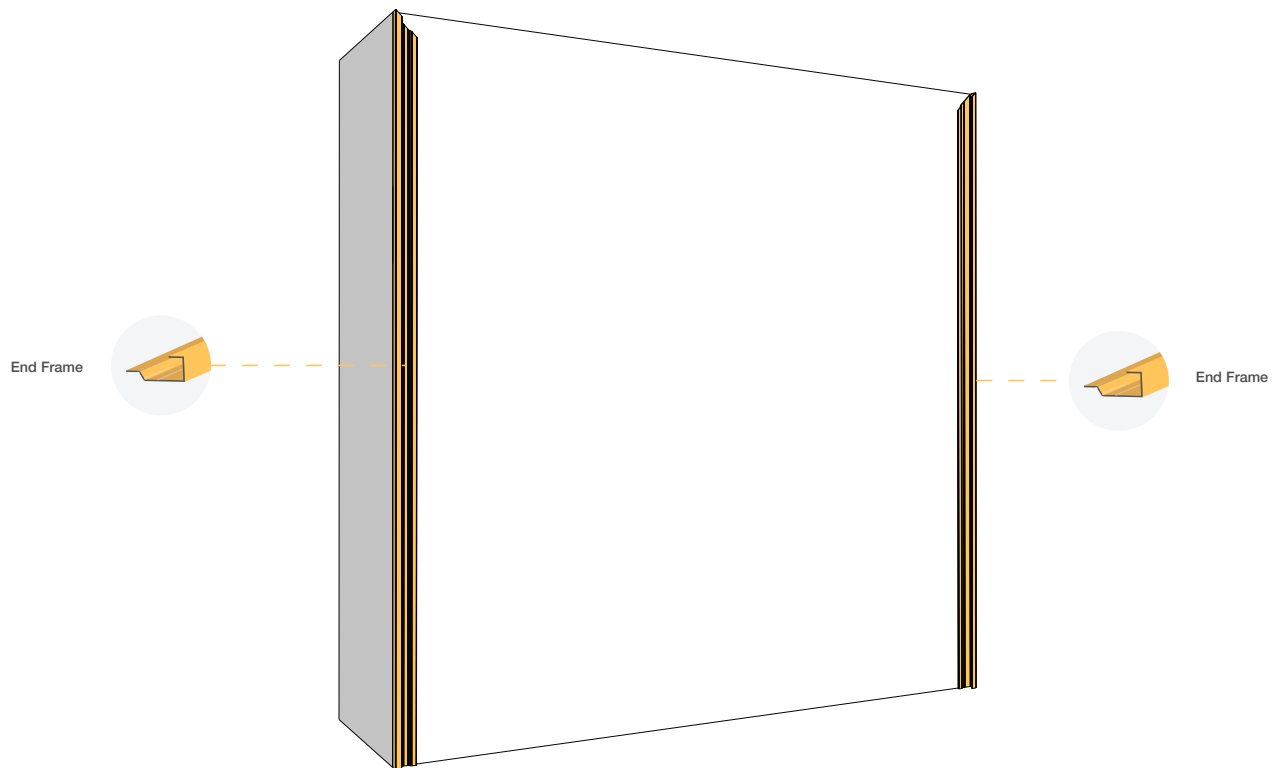

Measure and cut the vertical End Frames according to the marked grid lines. If the top of the vertical End Frame is to meet another horizontal End Frame at 90 degrees, a 45-degree mitre cut is to be made on both parts to complete the angle. This will eliminate the need to notch extrusions. If the wall is to be finished with a half back plate and perimeter cap, the 45-degree mitre is not necessary, as the horizontal cap will tuck behind the vertical end frames.

It is the preferred method to fasten the top part of the extrusion first (upper 3"), then the bottom (lower 3"), followed by all fasteners in between. Typical Fastener spacing on all extrusions with the 4mm ACM Panel system is to be no greater than 24" with a minimum of 2 fasteners per extrusion. Fastener spacing may be decreased, to add additional pull out capacity. Consult the product specifications to determine fastener type and spacing.

*\*An Outside Corner Frame, Inside Corner Frame, or a Perimeter Frame Assembly may be used in place of the End Frame in this situation. The End Frame is shown here only to keep the scope of this guide relatively simple.*

# 02

## Panel Install 04

Fasten top horizontal extrusion

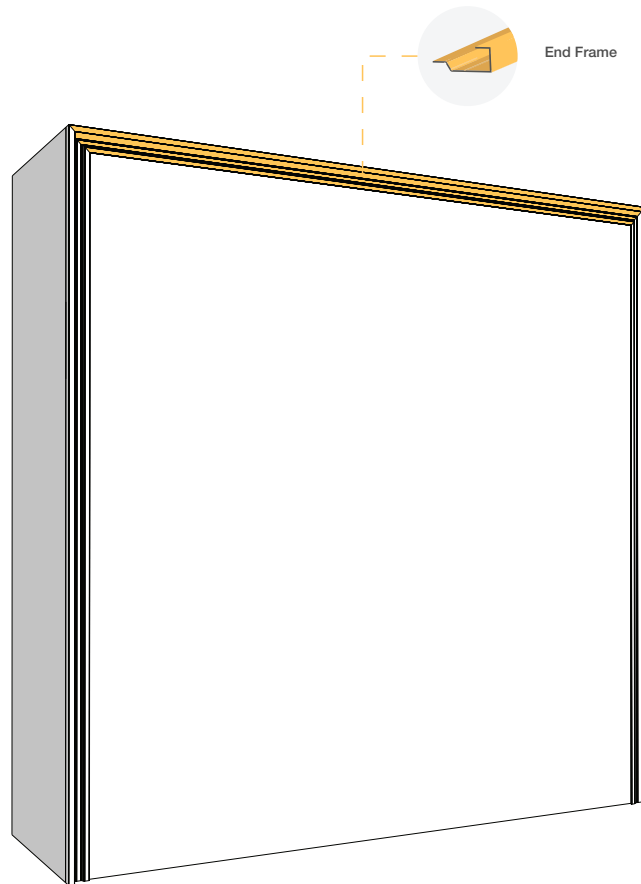

The upper End Frame is next to be measured and cut-to-size. A double mitre could be required if the vertical End Frames are mitered at 45-degrees (as outlined in the previous step).

If one length of the End Frame extrusion is not long enough to span the distance required, it is necessary to use a second piece and butt the two together. Take care in aligning joints so that they are flush, shim as needed.

# 02

## Panel Install 05

Fasten baseline extrusion backplates

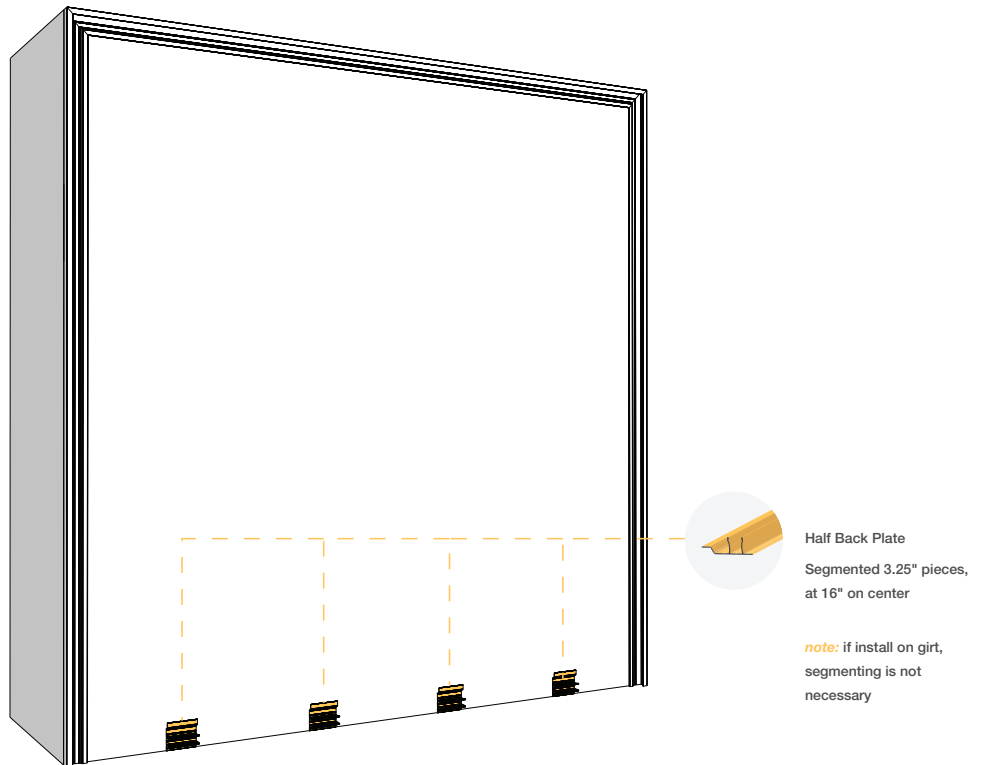

AL13's Panel System is a rain screen system that does not require any strapping.

The bottom row is comprised of segmented half back plate sections, cut to a length of 3.2" and installed every 16". This ensures that, at any given horizontal cutaway, only 20% of the material is attached to the wall to an 80% open cavity. This provides necessary capillary break and fulfills the rainscreen requirements.

# 02

## Panel Install 06

Fasten baseline extrusion

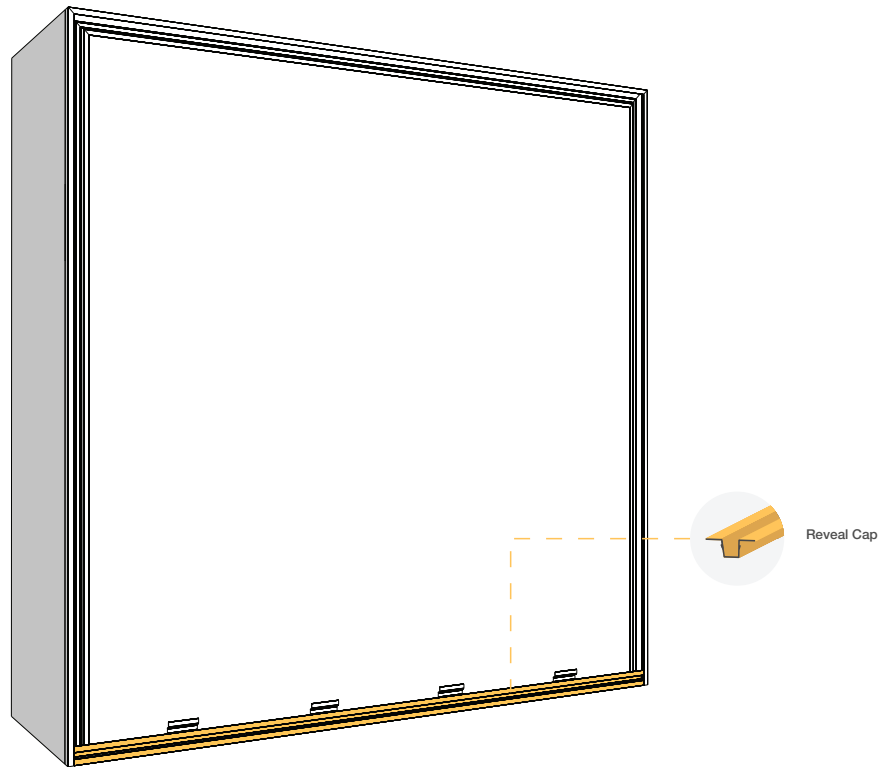

Measure and cut the bottom horizontal top cap. A proper fit will ensure that either end may be tucked into the vertical endframes, leaving a minimum 1/8" gap to allow for proper contraction and expansion of the extrusion.

Engage the top cap into the segmented back plates using an AL13° SLED with a rubber mallet. It is imperative to only make contact where back plates are present so as not to damage or warp the top cap.

# 02

## Panel Install 07

Fasten vertical back plate

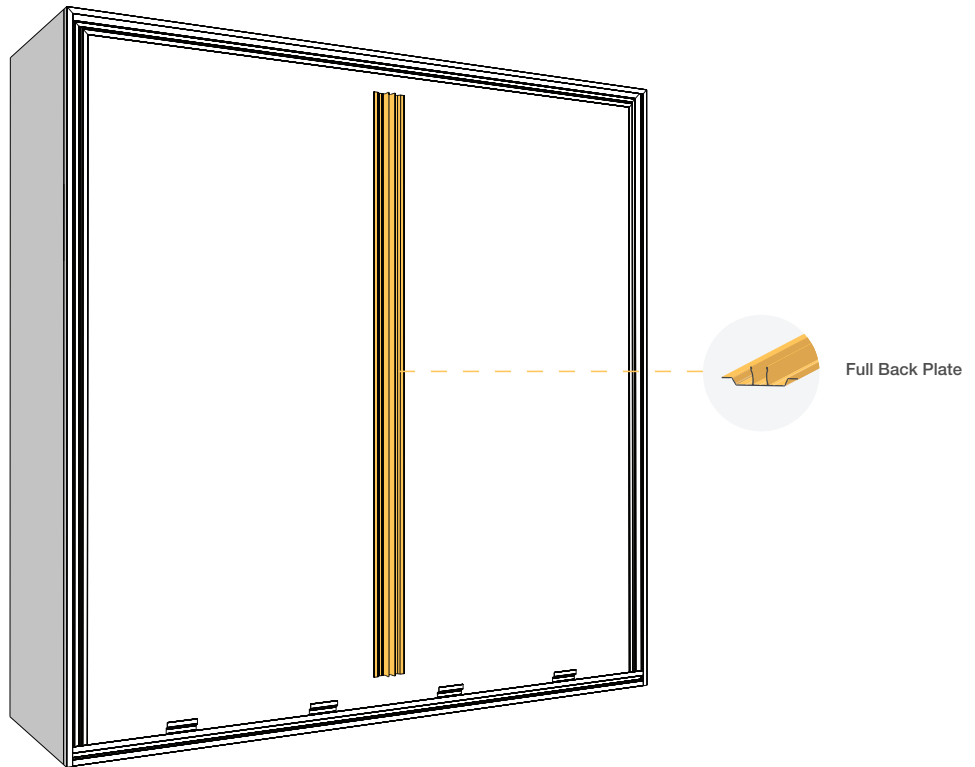

Measure and cut the vertical full back plate. Allow for approximately 2" gap from horizontal upper and lower extrusions to allow for proper top cap installation. Begin by fastening the top of the extrusion first (upper 3"), followed by the bottom (lower 3"), then the intermediate fasteners.

# 02

## Panel Install 08

Fasten horizontal full back plate segments



Measure and cut horizontal back plates in 3.25" segments and install them every 16" as per the layout. If you are fastening to a minimum of ½" ply or OSB sheathing, it is not necessary to fasten segments to a stud. It is recommended to pre-drill the holes in the segmented back plate pieces. This will prevent the small pieces from spinning while fastening - which aids in eliminating the possibility of a cut hazard.

It is important to install the segments ensuring they are completely plumb and straight. A Level or straight edge may be used to assist with alignment.



# 02

## Panel Install 09

Attach system clips

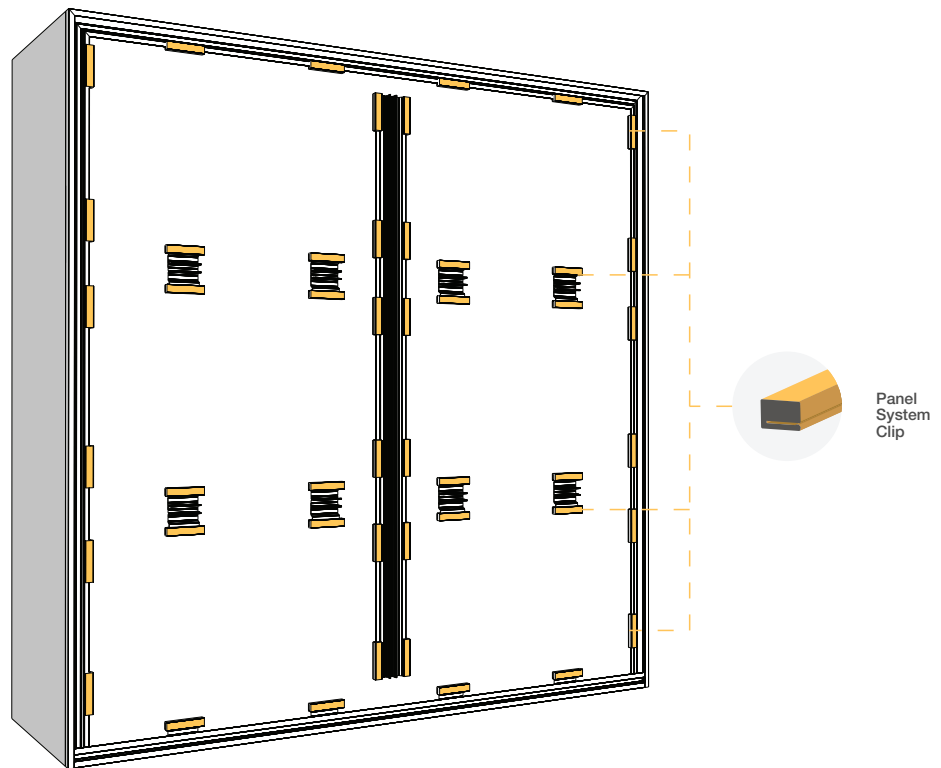

Once all extrusions have been installed it is time to attach system clips to all the extruded frame components. System clips act as spacers and are installed with the thin tab pointing towards the wall and the thicker portion facing away from the wall. System clips keep the panels tight to the frame without the need for adjustment.

System clips are to be attached at a minimum every 16", or 1 system clip per tab on the smaller segmented horizontal pieces. Position system clips 6-8" away from corners and intersections.

System clips are intended to be a firm and secure friction fit. Repeated attempts pulling the clip off and snapping it back on may weaken the integrity of a clip. Once a clip has been snapped in place, it should not be repeatedly taken off and snapped back on. If any clip is found to have been weakened through repetitive use, it should be discarded and a new one used in its place to ensure a secure fit.

# 02

## Panel Install 10

I-beam installation (optional)

Standard 4' x 8' sheet

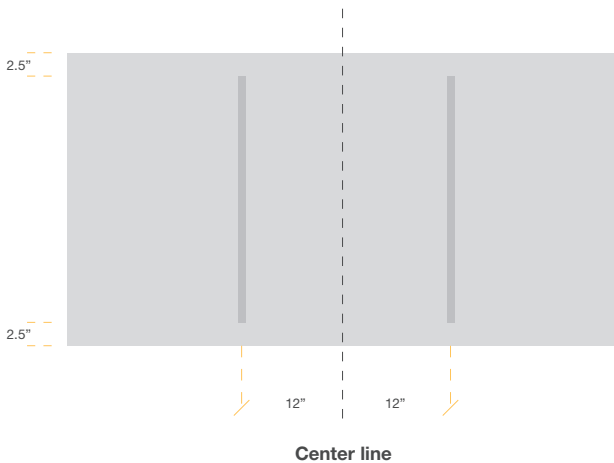

Cut sheet

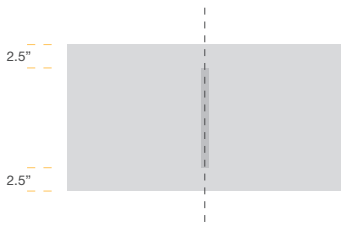

I-beams may be used in conjunction with the panels to provide additional panel rigidity.

**Step 1** - Cut I-beams to fit. Appropriate sizing should be offset from either edge of the panel 2 1/2". Full 4'x8' panels will require 2 I-beams set back 12" from center. Panels 6' or below only require 1 I-beam, running in the narrow direction, at the center of the panel.

**Step 2** - Ensure both of the surfaces are free of dirt, debris or contaminants to ensure full adhesion. For best performance it is suggested to clean both surfaces using Isopropyl Alcohol, which is free of solvents and will not damage any finished surfaces.

**Step 3** - Apply double sided adhesive the full length of the narrow leg of the I-beam. Remove the protective backing and carefully attach to the cleaned back side of the panel. Once set in position, apply pressure along the length of the I-beam to ensure even full contact with the back side of the panel.

# 02

## Panel Install 11

ACM panel fit

### IMPORTANT!

It's critical AL13® Panels are not cut too small relative to their frame components. Only a max 1/8 inch gap is allowed around the perimeter of the Panel.

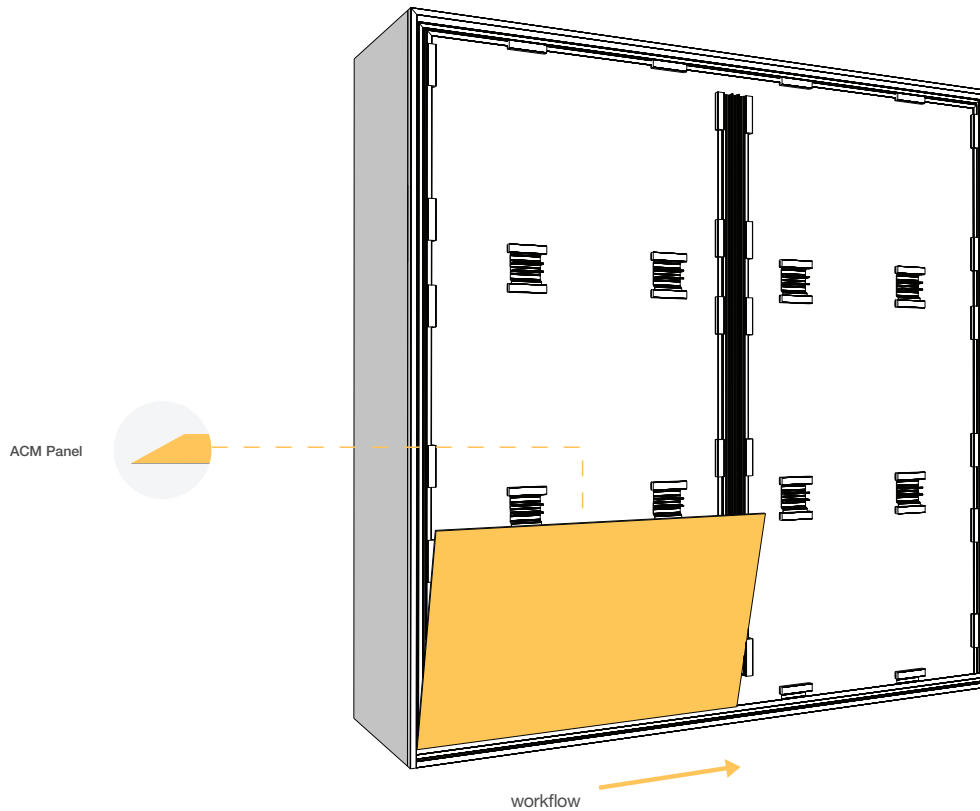

The ACM Panel may need to be cut down if a smaller size from the standard 4' x 8' (1220 x 2440 mm) is required. This may be done on a standard circular saw, panel saw or table saw - so long as an AL13® blade is used. Use a guide to ensure cuts are straight and clean.

The appropriate panel fit should account for approximately a 1/8" gap on all sides to allow for expansion and contraction of the metal.

Once a panel is ready to be fit, it may be taken off the stack. Make sure not to drag sheets across, rather lift the sheet up off the stack, then away. Although the panels have a protective film applied from the factory, reckless panel handling may cause damage to panel through the wrap. It is recommended that at least two persons carry one sheet. The protective film should be peeled back approximately 1" (25 mm) from the edges, but should remain on the panel otherwise. Gloves should be worn to keep panel clean and to protect hands from sharp edges.

*\* Suction cups are recommended for installing panels as they allow for much greater grip and free your hands from a potential pinch hazard.*

**Step 1** - position panel on its long edge, lift it up and place in position.

**Step 2** - shift the panel towards the wall.

**Step 3** - Once the panel is flush, slide it under the tab of the vertical End Frame.

# 02

## Panel Install 12

Install reveal cap and lock into place with AL13° sled

**IMPORTANT!**  
Make sure Top Caps are fully engaged. Hammer the AL13° SLED firmly to engage with Back Plate. When backplate is segmented only hammer on top on the Back Plate segments.

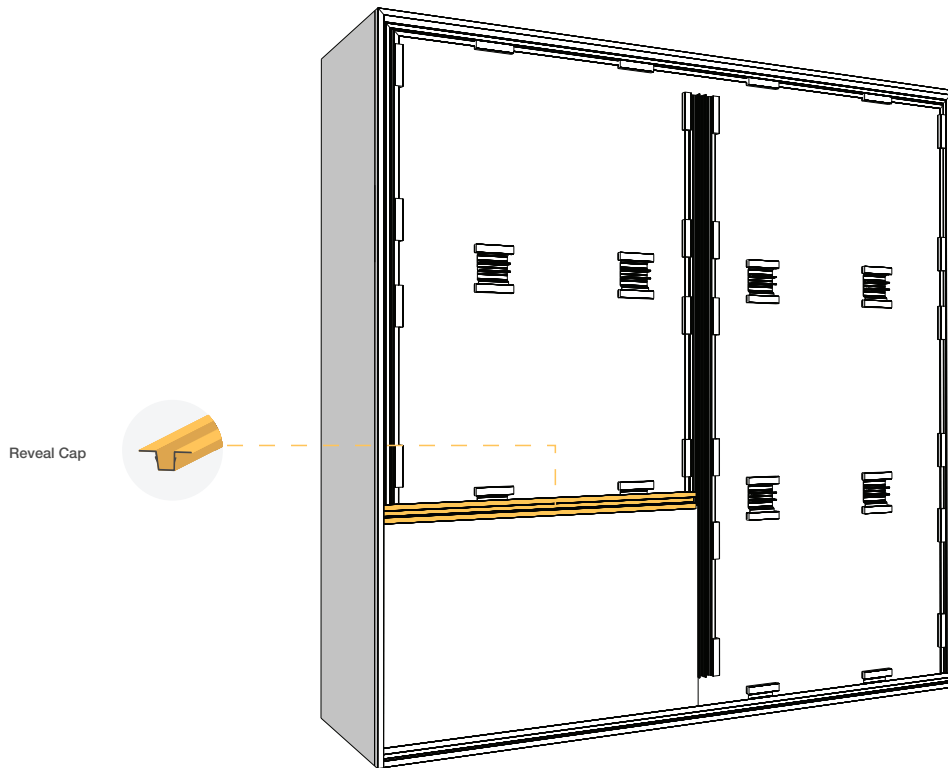

After the ACM Panel has been shifted into the correct position you must securely fasten it in place with a top cap. The top cap is the second part of the two-part Panel Frame Assembly which is snapped into place with a rubber mallet and the AL13° SLED.

Once the top cap is cut to the appropriate length, it may be engaged with a rubber mallet and the AL13° SLED. Where a horizontal top cap intersects a vertical End Frame, it should slide under the tab of the End Frame. Be cautious to only impact the top cap where a back plate is present to prevent any deformation of the frame components. The horizontal top cap should sit halfway under the tabs of the vertical frame components, in the same manner as the panel. Therefore, the horizontal top cap may be cut and positioned to match the panel.

# 02

## Panel Install 13

Repeat previous two steps for the next panel

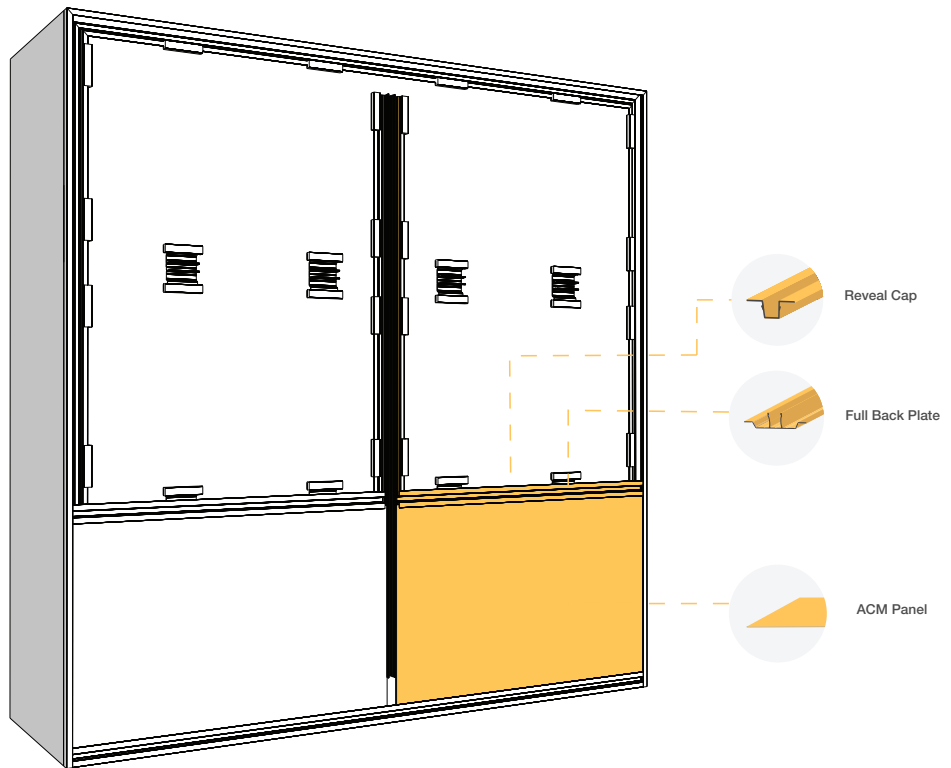

Continue workflow to the right and repeat previous steps for remaining panels on the first row of the wall.

# 02

---

## Panel Install 14

---

install top two panels

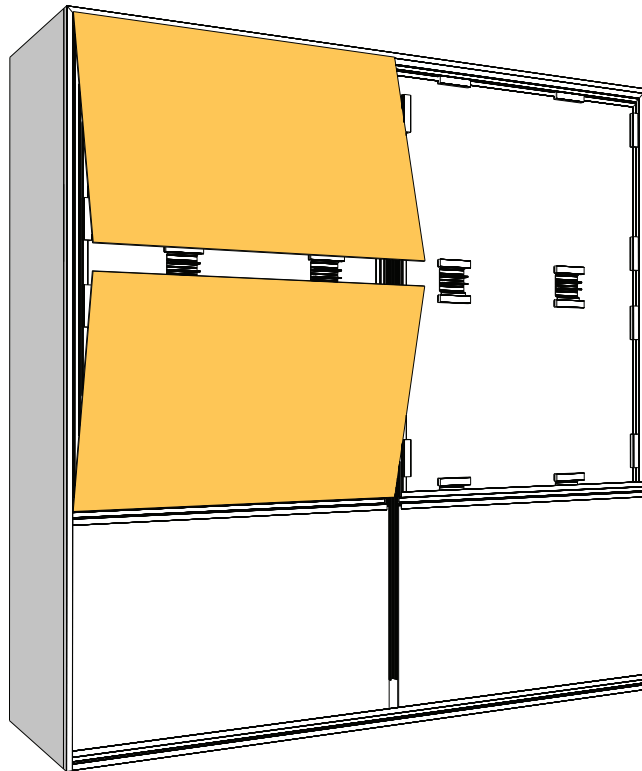

---

The top two panels in a column must be installed simultaneously. Since the top of the wall terminates under the horizontal End Frame, it would be impossible to place the upper panel if the below top cap was already secured.

**Step 1** - Install lower panel and hold in place while second panel is fitted.

**Step 2** - Slide upper panel upwards under the tab of the horizontal End Frame.

**Step 3** - Slide the panel underneath the vertical End Frame.

# 02

---

## Panel Install 15

---

Lock top panels into place with the top cap

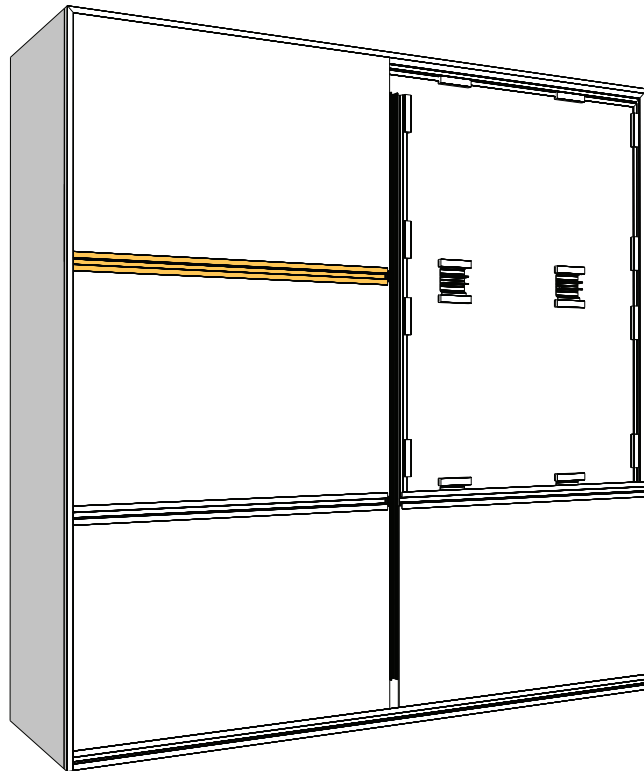

---

After the ACM Panels have been shifted into the correct position, the horizontal top cap will secure the panels in place. Once the top cap is cut to the appropriate length, it should be placed, one end first, into place, with each end under the tabs of the horizontal End Frames. Once in the correct position it is to be hammered into place with a rubber mallet and AL13° SLED.

# 02

---

## Panel Install 16

---

Repeat for the other side and lock into place

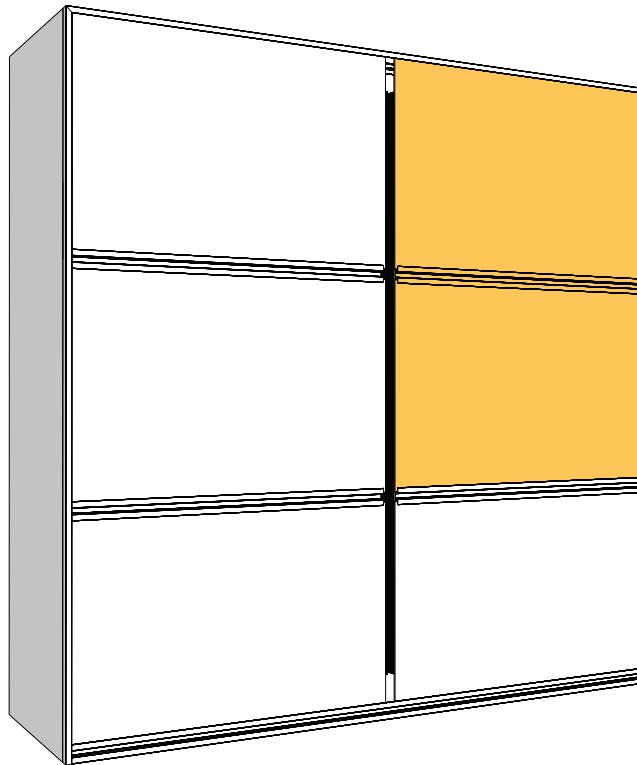

---

Continue workflow to the right and repeat previous steps for remaining panels on the top row.



# 02

## Panel Install 17

Install vertical top cap and lock into place

### IMPORTANT!

It is critical when two Top Caps meet the joint should take place on the same Back Plate, and at least 6 inches away from any intersection.

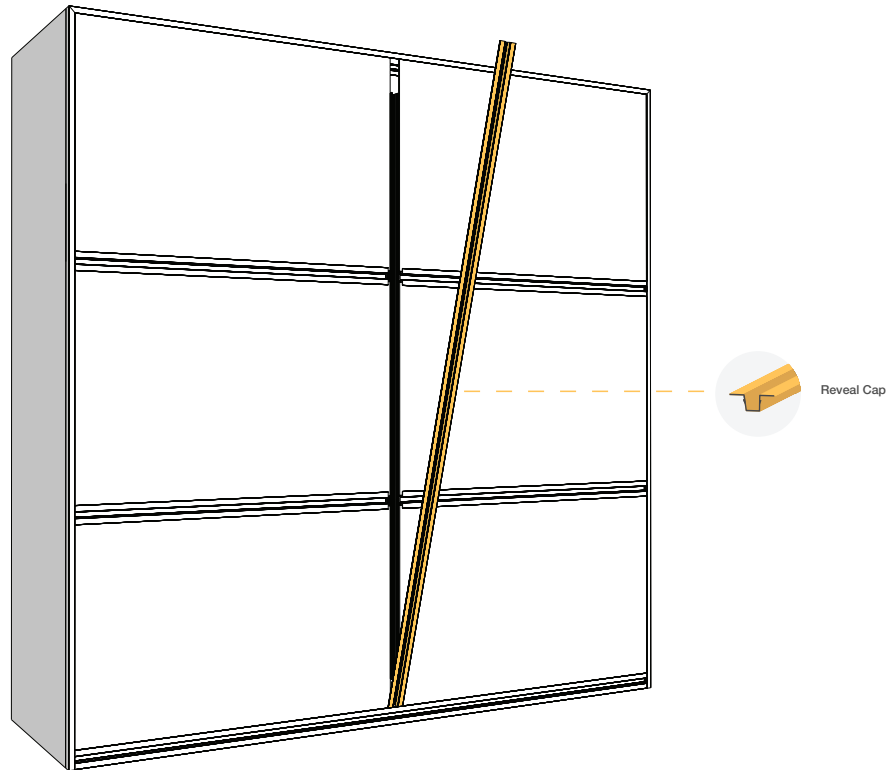

Once two adjacent columns of panels have been installed, the top cap may be installed. Once the top cap is cut to the appropriate length it should be placed, bottom end first, into place, with each end under the tabs of the horizontal End Frames. Once in the correct position it is to be hammered into place with a rubber mallet and AL13° SLED.

If one length of the top cap extrusion is not long enough to span the distance required, it is necessary to use a second piece and butt the two together. Take care in aligning butt-joints so that they share the same back plate. Do not butt two top caps at an intersection, where no back plate is present.

# 02

## Panel Install 18

Wall installation is complete

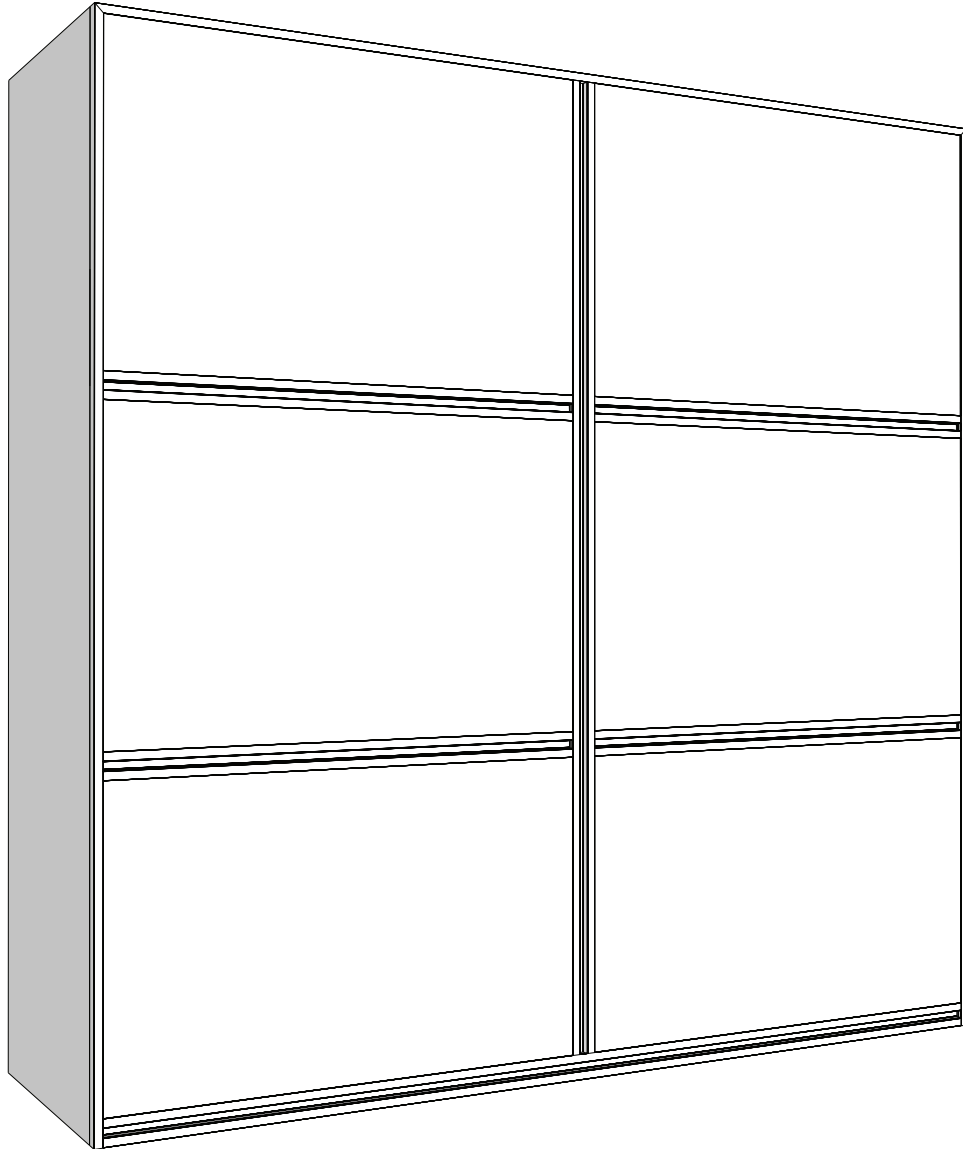

# 02

---

## Panel Install 19

---

Finishing and inspection



---

Once the install is complete, work from the top down to remove the protective plastic film and clean the panels as required. Take note of any installation flaws and ensure all top caps are fully hammered into place.

***Protective film must be removed once install in complete.***

# 02

---

## Panel Install 20

### Further situations

This General Install guide is intended to show the best practices for a basic install and how the various components work together. It is outside the scope of this manual and impossible to anticipate & outline every installation situation that may be encountered. In order to present the install in the most clear and direct manner, there are a few standard situations that are not covered in this guide. These situations are shown in detail in the following Drawings section, however the below guide will describe how they would install relative to this guide.

---

### Component



End Frame

Generally installed in a vertical or horizontal orientation and is used to terminate the wall system or butt/transition to another wall surface. May be used to butt up to the frames of windows, doors or any other protrusions and recesses in the wall surface.



Inside Corner

Generally installed in a vertical orientation and is used to transition the wall system across a 90° inside corner. May be installed in the same sequence and manner as the Vertical End Frame.



Outside Corner

Generally installed in a vertical orientation and is used to transition the wall system across a 90° outside corner. May be installed in the same sequence and manner as the Vertical End Frame.



Flat Cap

This extrusion is installed both horizontally and vertically. It is generally installed between adjacent panels to connect them. Mates with Half or Full Backplate.



Perimeter Flat Cap

Generally installed horizontally or vertically to terminate the panel system on the wall. It is to be used at the bottom-of-wall panel termination if it is visible from the underside. It can also be used as an alternate to the End Frame or Inside Corner and Outside Corner Frame extrusions. Mates with Half or Full Backplate.



Reveal Cap

This extrusion is installed both horizontally and vertically. It is generally installed between adjacent panels to connect them. Mates with Half or Full Backplate.



Perimeter Reveal Cap

Generally installed horizontally or vertically to terminate the panel system on the wall. It is to be used at the bottom-of-wall panel termination if it is visible from the underside. It can also be used as an alternate to the End Frame or Inside Corner and Outside Corner Frame extrusions. Mates with Half or Full Backplate.

# 02

---

## Panel Install 21

### Component



Half Back Plate

Generally installed in a vertical or horizontal orientation and is used to terminate the panel system on the wall. Mates with Cap profiles.



Full Back Plate

Generally installed in a vertical or horizontal orientation and is used to terminate the panel system on the wall. Mates with Cap profiles.



I-Beam

I-beams may be used in conjunction with the ACM panels to provide additional panel rigidity.



4mm Panel System Clip

Systems clips act as spacers and are installed every 16" - keeping the panels tight to the frame and away from the wall without the need for adjustment.



3mm Panel System Clip

Systems clips act as spacers and are installed every 16" - keeping the panels tight to the frame and away from the wall without the need for adjustment.

---

In general, the vertical extrusions carry through and the horizontal extrusions are segmented and tuck under the tab of the verticals. Please consult AL13<sup>®</sup> should there be any questions regarding specialized configurations that are not covered in this installation guide or in the drawing section.

# 03

---

## Fastener Specifications

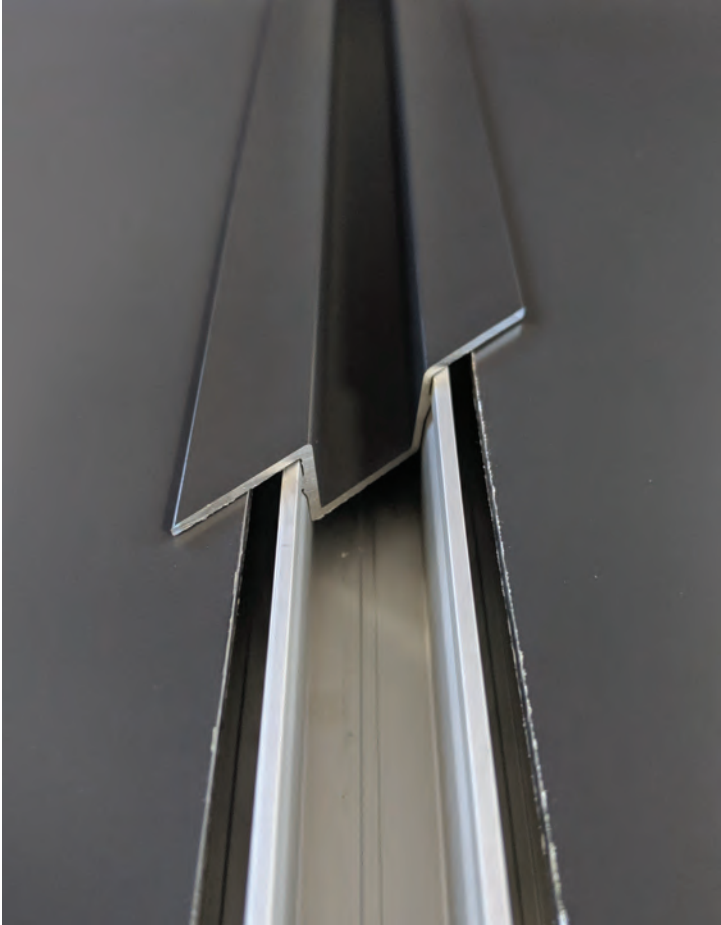

---

### **AL13° general installation specifications**

For sheathed wood frame, AL13° installs directly on building wrap. The mechanical fasteners anchor into building sheathing and studs where available.

### **AL13° panels**

Panels are fastened by the frame tabs around the entire perimeter. No traditional mechanical fasteners are required in the panel itself.

# 03

## Fastener Specifications

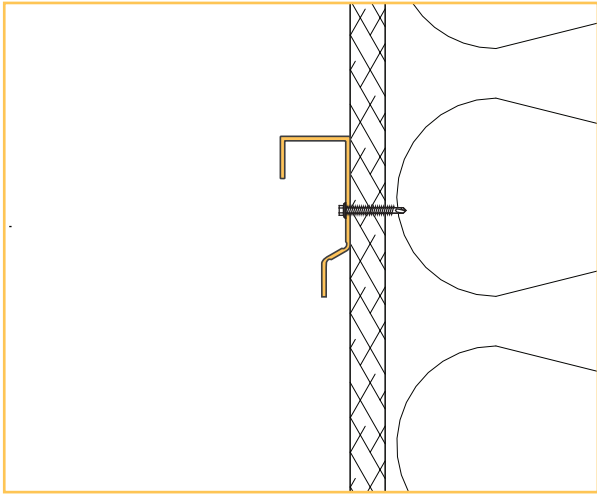

Typical Fastener Install in sheathing - End Frame

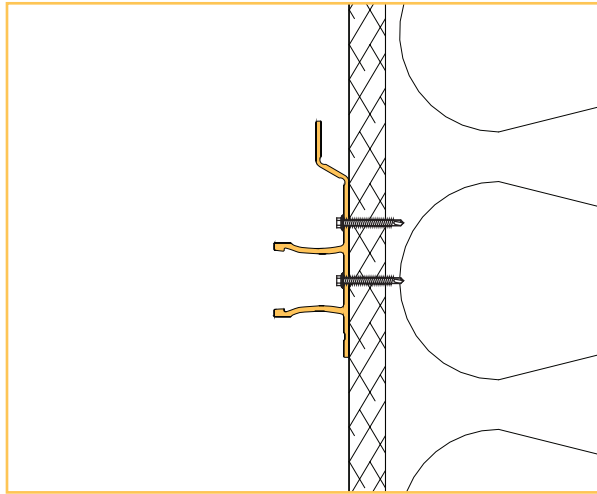

Typical Fastener Install in sheathing - Half Backplate