



CERACLAD
Triple-Coated Rainscreen Siding Systems

Product Brochure

Superior cladding solutions for sustainable buildings and a healthy living environment

30-Year Product
Limited Warranty

–

20-Year Fade
Resistance Limited
Warranty

–

Self Cleaning Finish

–

Hundreds of Cladding
Design Options

CERACLAD'S TRIPLE COATING TECHNOLOGY...

1. Colored Layer

Factory finished, available in proprietary colors

2. Ceramic Coating Layer

Excellent UV blocking properties, 20-year Fade Limited Warranty



3. Photocatalytic Coating Layer

Self-Cleaning / Air-purifying / Anti-virus and Anti-bacterial

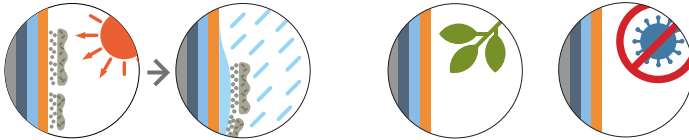

...IS SELF-CLEANING 365 DAYS A YEAR

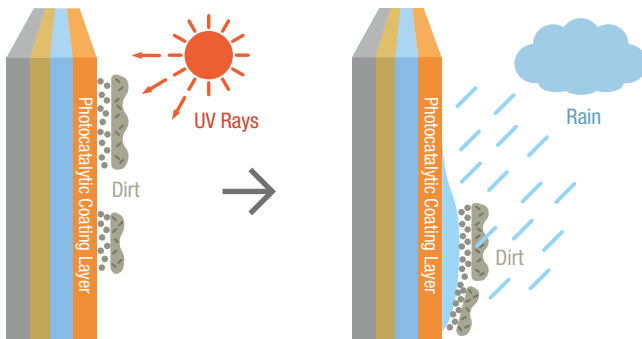

When exposed to sunlight, the Titanium Oxide layer breaks down dirt and reduces adherence.

The super-hydrophilic property helps rainwater penetrate under dirt, displaces it, and then washes it away.

Decomposition power + Super hydrophilic property

1. Design Versatility



2. High Performance

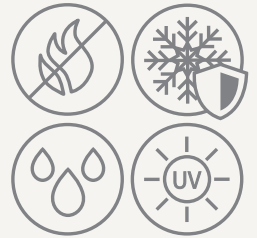

3. Moisture Management

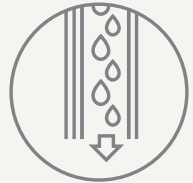

4. Cost Effective



5. Eco-Friendly



Virtually Unlimited Design Options

Design to match your unique aesthetic with our customizable panels, available in dimensions of L: 10' (3030mm) × W: 18" (455mm) × T: 5/8" (16mm). These adaptable modules can be cut to any length on site, combined in various colors, and installed in both horizontal and vertical orientations. Whether you prefer stack bond, running bond, or other layout patterns, our flexible design options are tailored to bring your vision to life.



Reliable Product Quality

Our products are made to perform in any climate. CERACLAD panels come with a 30-year Product Warranty and a 20-year Finish Warranty. Featuring a triple coating that includes ceramic and photocatalytic layers, they offer exceptional color stability and self-cleaning properties for long-lasting vibrancy. Certified for freeze-thaw durability, as well as fire and wind resistance, our panels meet rigorous standards in both the US and Canada.



Durable and Healthy System

Our integrated Rain Screen System promotes ventilation behind the cladding, helping to prevent mold and algae growth, ensuring a safer and more durable building.

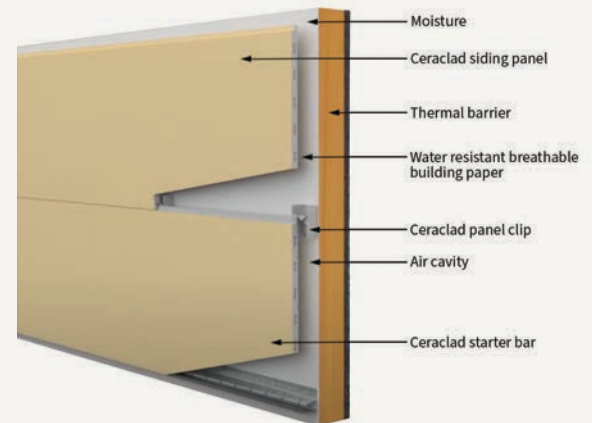

Clear Pricing Package

Our transparent pricing system offers a standard rate for all textures, eliminating the need for off-site fabrication or shop drawings. Our caulk-free installation process reduces both costs and time. Plus, with our color warranty and self-cleaning technology, you can minimize maintenance expenses and maximize your return on investment.

Environmentally Friendly Product

Our panels are made from approximately 45% recycled materials and come with independently verified Health Product Declaration (HPD) and Environmental Product Declaration (EPD) statements. Additionally, we are committed to achieving zero carbon emissions by 2050, working towards becoming the most eco-friendly fiber cement siding available.



DESIGN OPTIONS

CERACLAD siding panels come in a wide range of rich textures and colors and provide you with hundreds of possible combinations. And our exclusive **CREATIV[®]** custom color program allows you to order your components in colors that will match your exact specifications.

STANDARD SERIES



Cashmere Smooth



Zen Garden



Modern Stripe

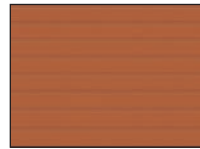

8 Reveal

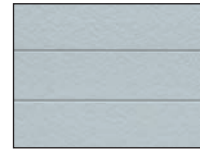

3 Reveal

WOOD SERIES



Urban Cedar



Rustic Wood



Barnwood



Antique Sawn



Elements/Walnut



Sho Sugi Ban

CONCRETE SERIES



Board Formed
Concrete



Cast Stripe

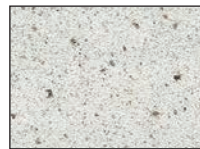

Elements/
Exposed Aggregate



Elements/Ashlar
Slate



Elements/Weathered
Concrete

IMPRESSION SERIES

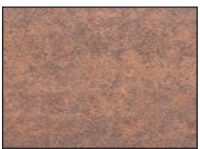

Elements/Corten
Steel

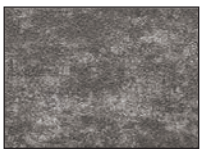

Elements/Blacken
Steel



Strahl

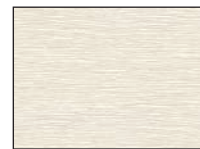

Fiotto



Mosaic Tile

STONE AND BRICK SERIES



Antique Brick



Modern Brick



Gridline



Granite

Textures and Finishes

COMBINE TEXTURES FOR A UNIQUE LOOK

Creating a unique look for your properties is easier with Ceraclad panels since all our textures are available for the same price. Mix and match textures and colors to achieve a look that your brand can own. Talk to one of our sales representatives to learn more.

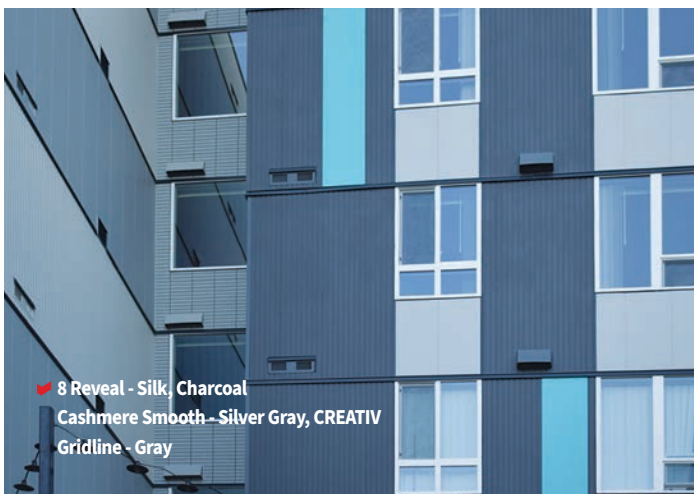

CERACLAD SIDING PANELS ARE VERSATILE FOR ALL TYPES OF PROJECTS.

MULTIFAMILY

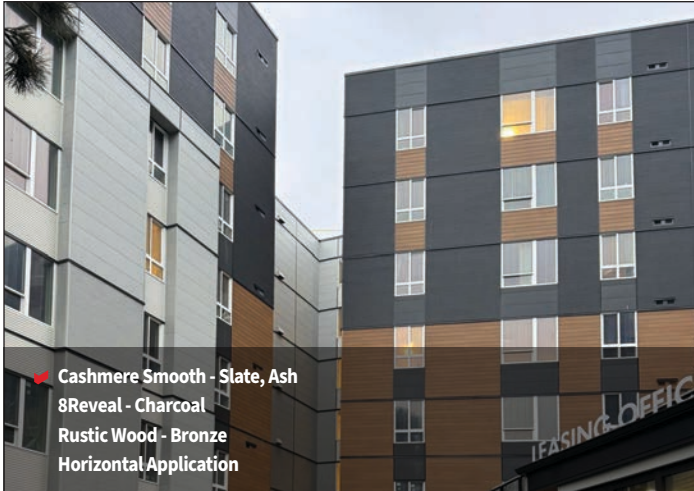

MEDICAL



CORPORATE

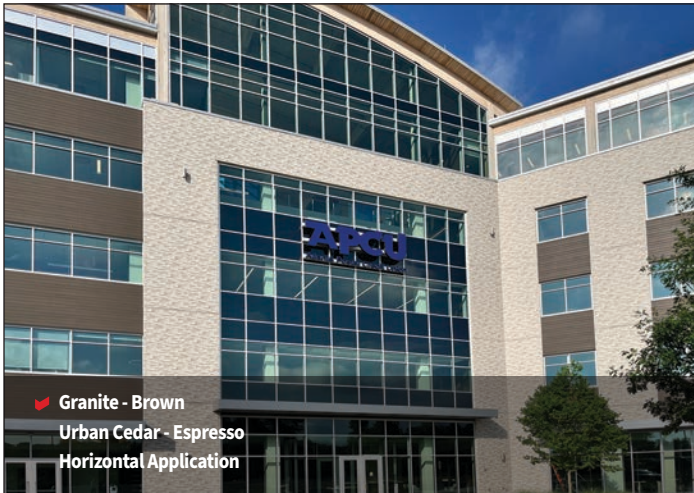

MODULAR



EDUCATION



Project Types

HOSPITALITY



RETAIL



SENIOR HOUSING



NATIONAL BRAND



INDUSTRIAL

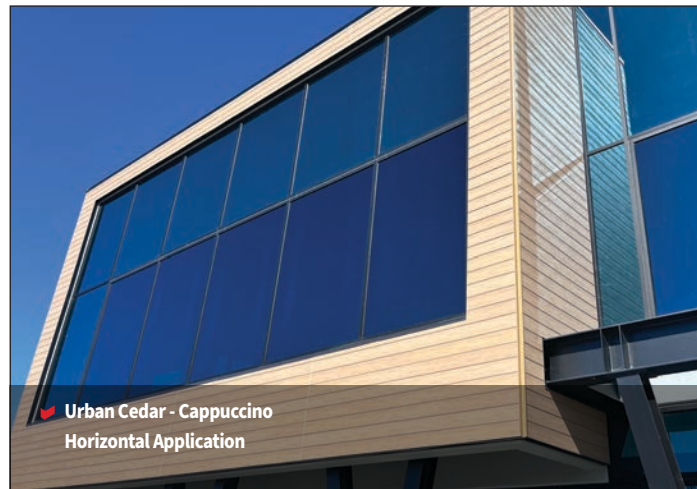

Custom Color Program

CUSTOM COLOR COATING CREATIV™ PANELS

Choose your unique color with our **CREATIV** custom color program. CERACLAD **CREATIV** panels feature a color coat followed by a protective clear coat, shielding them from ultraviolet rays and minimizing exterior discoloration. Unlike other custom color products that use only one color coat, our extra layer of protection reduces or eliminates the need for repainting, thereby lowering maintenance costs. Our proprietary colors and clear coatings are factory-applied to ensure superior quality, with two finish coats to help prevent fading.

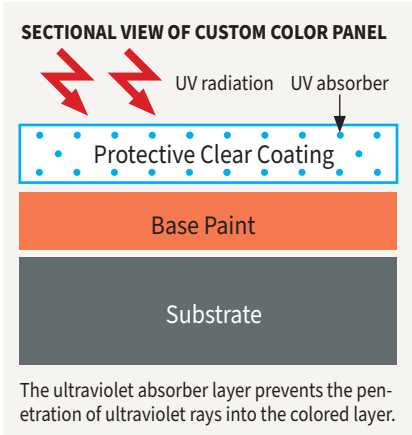

CUSTOM COLOR FINISHES	
CREATIV®	OTHERS
2-Coat Finish	1-Coat Finish





Transform Architecture Into Art

Turn ordinary façades into extraordinary expressions. The Mural Program allows architects, designers, and owners to create custom wall art that integrates seamlessly into building envelopes — elevating architecture from structure to statement.

Program Overview:

The Mural Program is a full-service solution designed to turn architectural surfaces into large-scale art installations. From concept development to production and installation, our team provides comprehensive support, enabling your creative vision to become a permanent part of the built environment.

Program Features

Unlimited Design Possibilities – Bring any vision to life, from photography and artwork to graphics, logos, and patterns, all directly on the façade.

Architectural Impact – Transform the exterior into a storytelling canvas that reflects brand identity, cultural context, or community values.

Seamless Integration – Compatible with our existing panel system, the mural surface integrates easily into architectural design and construction workflows.

COLOR PALETTE

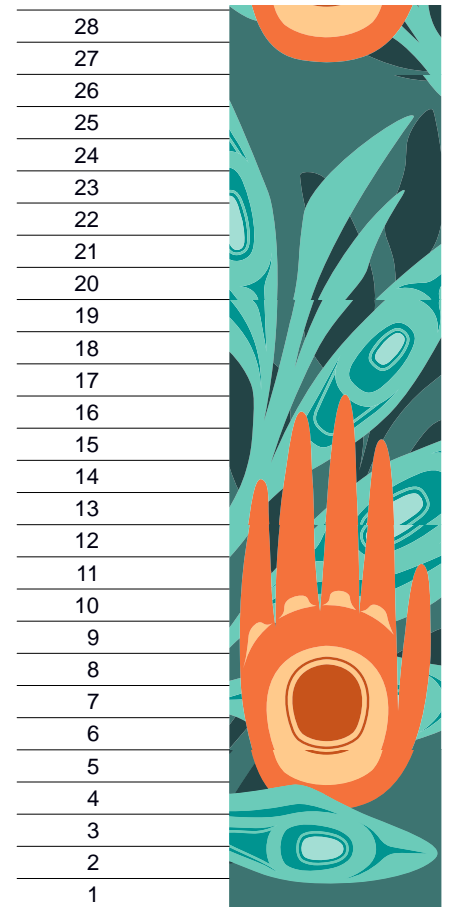
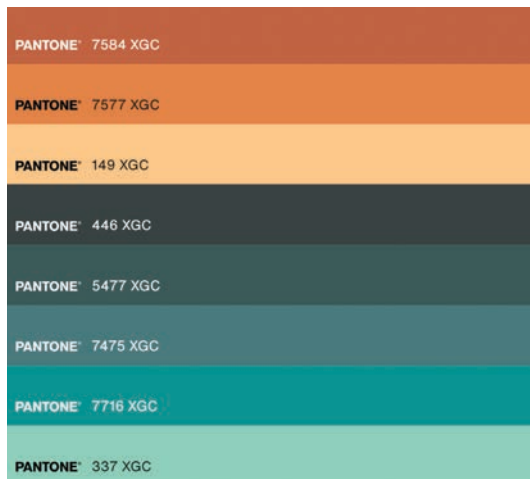

OF PANELS

MURAL 1

CREATIV Mural Program

Program Steps:

- 1. Design Consultation:** Collaborate with our design team to define the concept, visual style, and artistic direction of the mural.
- 2. Artwork Submission:** Provide high-resolution artwork or design files. Our technical specialists will review the data to ensure print compatibility and color accuracy.
- 3. Mock-up & Review:** We produce small-scale sample panels for your review, allowing you to evaluate color accuracy, surface texture, and visual quality before final production.
- 4. Production:** Final artwork is printed in high-resolution to deliver a vibrant and durable mural surface.
- 5. Delivery & Installation:** Panels are shipped to the jobsite and installed seamlessly, transforming the building into a distinctive work of art.

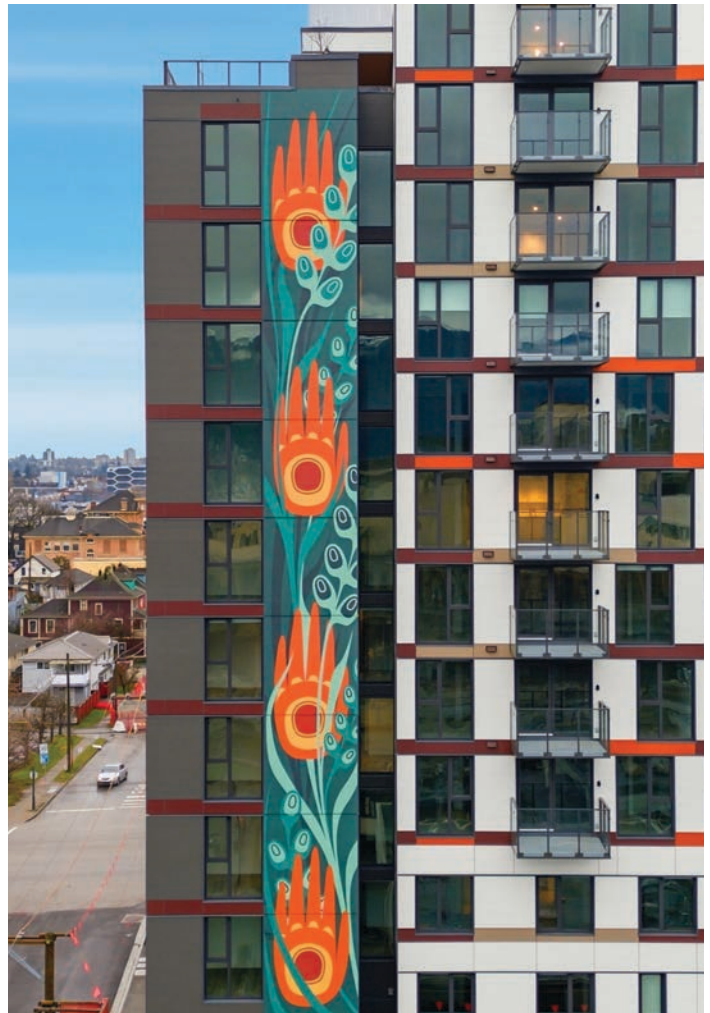
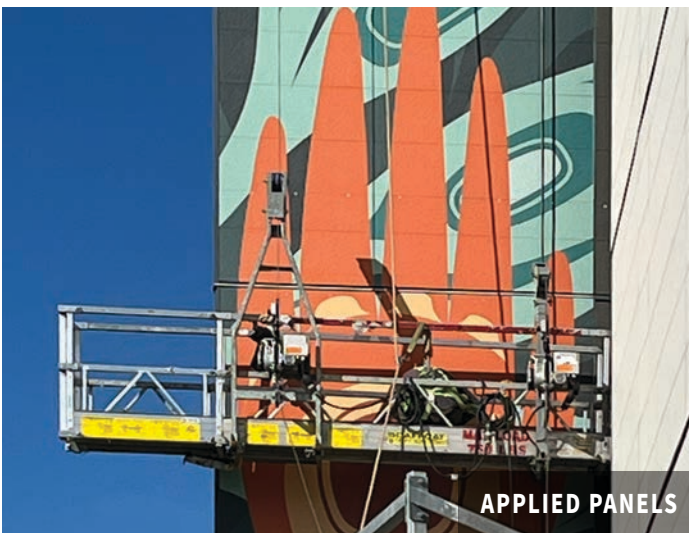



CERACLAD® Triple Coated
Fiber-Cement Siding Caulk-Free
Rainscreen System

20-Year Fade Limited Warranty • 365 Days Self Cleaning • Low Maintenance

CREATIV® custom color program is available in this texture. Custom color samples can be requested at: ceraclad.com/creativ-custom-color

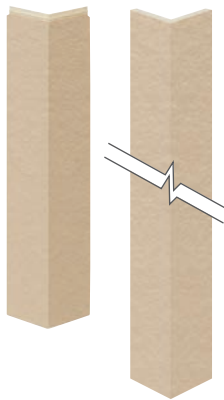

BASIC SPECIFICATIONS	
Panel Type	Solid-Core
Application Method	Vertical or Horizontal
Joint Type	Caulk Free
Coating Options	Triple Coated (15 colors) Creativ™ Custom Colors
Dimensions (Nominal)	W: 18" (455 mm) L: 10' (3030 mm) T: 5/8" (16 mm)
Coverage	15 ft ² (1.38 m ²)
Weight	60 lb. (27 kg)
The Triple Coating is super weather resistant, low maintenance, and backed by a 20-year fade limited warranty.	
Please visit our website for additional CERACLAD product information including: <ul style="list-style-type: none"> • Product samples • Custom color samples • Specifications • CAD details • Product performance and approval documents • MSDS 	

FACTORY STANDARD COLORS



Arctic White
HFH9161A



Pearl
HFH9162A



Silk
HFH9163A

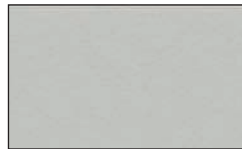

Silver Gray
HFH9164A

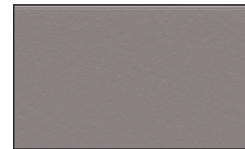

Mid Gray
HFH9165A

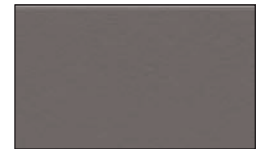

Dusky Gray
HFH9166A



Slate
HFH9167A

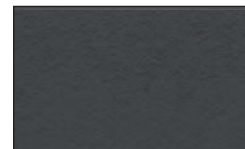

Charcoal
HFH9168A



Wheat
HFH9169A

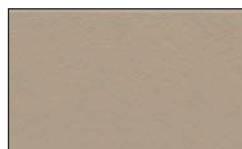

Brass
HFH91610A

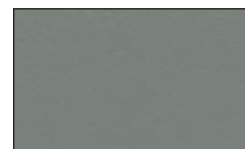

Willow Gray
HFH91616A

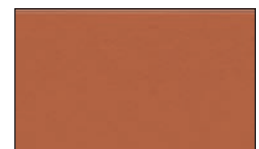

Saffron
HFH91612A



Blue Gray
HFH91617A

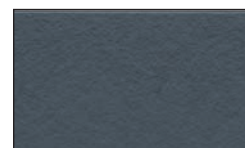

Midnight Blue
HFH91614A

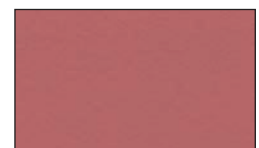

Sienna Blush
HFH91618A

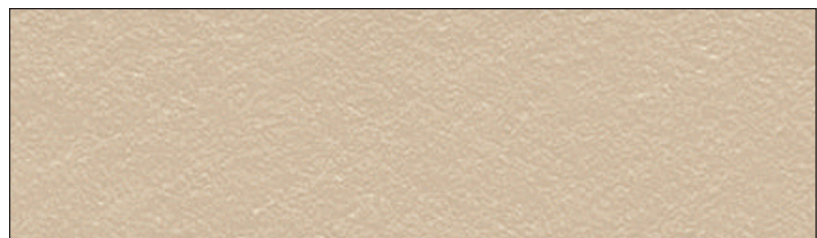

Wheat | HFH9169A

1. The product color tones on this sheet may appear slightly different from the actual products. Final color selection should be made from product samples.
2. Colors and textures are subject to change.
3. Damage caused by any product installation, repair, or replacement that is not in accordance with KMEW's technical manual, as well as damage caused by product installation on inappropriate buildings/structures, is specifically excluded from warranty coverage. Please review KMEW's technical manual and website for this product.

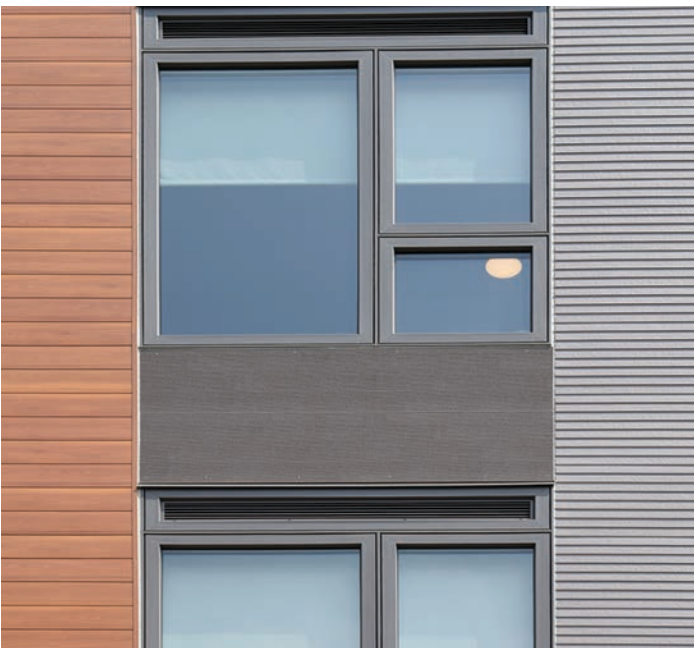

CERACLAD® Triple Coated Fiber-Cement Siding Caulk-Free Rainscreen System

20-Year Fade Limited Warranty • 365 Days Self Cleaning • Low Maintenance

CREATIV® custom color program is available in this texture. Custom color samples can be requested at: ceraclad.com/creativ-custom-color

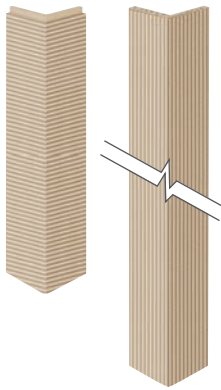

BASIC SPECIFICATIONS	
Panel Type	Solid-Core
Application Method	Vertical or Horizontal
Joint Type	Caulk Free
Coating Options	Triple Coated (15 colors) Creativ™ Custom Colors
Dimensions (Nominal)	W: 18" (455 mm) L: 10' (3030 mm) T: 5/8" (16 mm)
Coverage	15 ft ² (1.38 m ²)
Weight	49 lb. (22 kg)
The Triple Coating is super weather resistant, low maintenance, and backed by a 20-year fade limited warranty.	
Please visit our website for additional CERACLAD product information including: <ul style="list-style-type: none"> • Product samples • Custom color samples • Specifications • CAD details • Product performance and approval documents • MSDS 	

FACTORY STANDARD COLORS



Arctic White
HFH9121U



Pearl
HFH9122U



Silk
HFH9123U

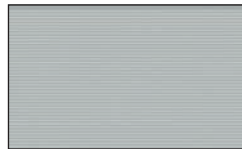

Silver Gray
HFH9124U

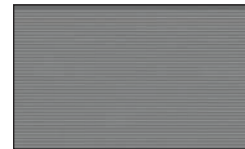

Mid Gray
HFH9125U

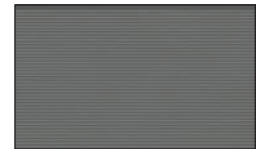

Dusky Gray
HFH9126U

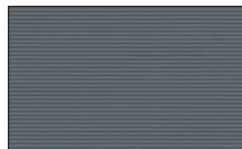

Slate
HFH9127U

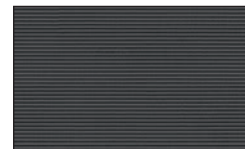

Charcoal
HFH9128U



Wheat
HFH9129U



Brass
HFH91210U



Willow Gray
HFH91216U



Saffron
HFH91212U



Blue Gray
HFH91217U

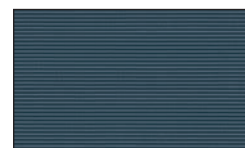

Midnight Blue
HFH91214U

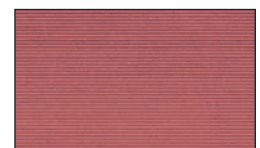

Sienna Blush
HFH91218U



Wheat | HFH9129U

1. The product color tones on this sheet may appear slightly different from the actual products. Final color selection should be made from product samples.
2. Colors and textures are subject to change.
3. Damage caused by any product installation, repair, or replacement that is not in accordance with KMEW's technical manual, as well as damage caused by product installation on inappropriate buildings/structures, is specifically excluded from warranty coverage. Please review KMEW's technical manual and website for this product.

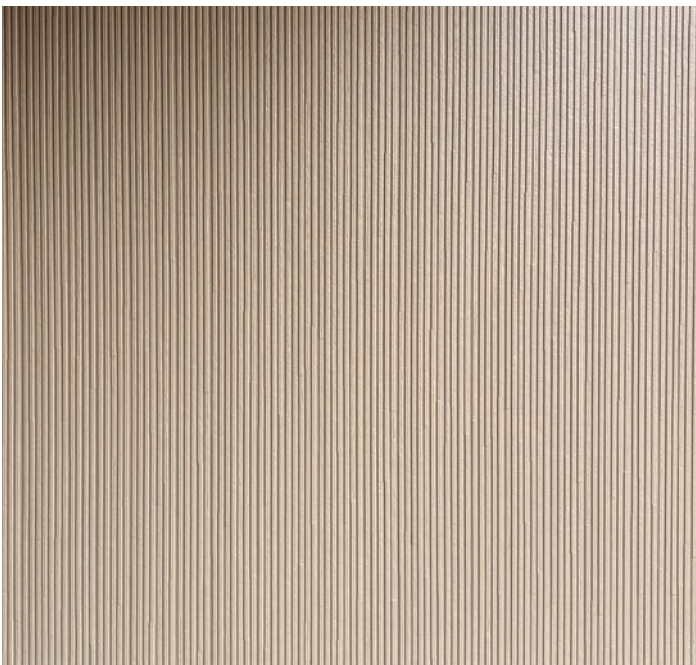

CERACLAD® Triple Coated
Fiber-Cement Caulk-Free
Siding Rainscreen System

20-Year Fade Limited Warranty • 365 Days Self Cleaning • Low Maintenance

CREATIV® custom color program is available in this texture. Custom color samples can be requested at: ceraclad.com/creativ-custom-color

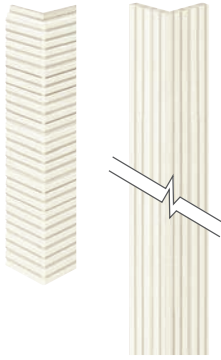

FACTORY STANDARD COLORS



Arctic White
HFH9181U



Pearl
HFH9182U



Silk
HFH91813U



Silver Gray
HFH9184U



Mid Gray
HFH9185U



Dusky Gray
HFH91816U



Slate
HFH91817U



Charcoal
HFH9188U



Wheat
HFH9189U



Brass
HFH91810U



Willow Gray
HFH9186U



Saffron
HFH91812U



Blue Gray
HFH9187U

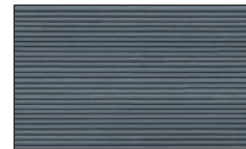

Midnight Blue
HFH91814U



Sienna Blush
HFH91818U



Mid Gray | HFH9185U

BASIC SPECIFICATIONS	
Panel Type	Solid-Core
Application Method	Vertical or Horizontal
Joint Type	Caulk Free
Coating Options	Triple Coated (15 colors)
Dimensions (Nominal)	W: 18" (455 mm) L: 10' (3030 mm) T: 5/8" (16 mm)
Coverage	15 ft ² (1.38 m ²)
Weight	55 lb. (25 kg)
The Triple Coating is super weather resistant, low maintenance, and backed by a 20-year fade limited warranty.	
Please visit our website for additional CERACLAD product information including: <ul style="list-style-type: none"> • Product samples • Custom color samples • Specifications • CAD details • Product performance and approval documents • MSDS 	

1. The product color tones on this sheet may appear slightly different from the actual products. Final color selection should be made from product samples.
2. Colors and textures are subject to change.
3. Damage caused by any product installation, repair, or replacement that is not in accordance with KMEW's technical manual, as well as damage caused by product installation on inappropriate buildings/structures, is specifically excluded from warranty coverage. Please review KMEW's technical manual and website for this product.



CERACLAD® Triple Coated Fiber-Cement Siding Caulk-Free Rainscreen System

20-Year Fade Limited Warranty • 365 Days Self Cleaning • Low Maintenance

CREATIV® custom color program is available in this texture. Custom color samples can be requested at: ceraclad.com/creativ-custom-color

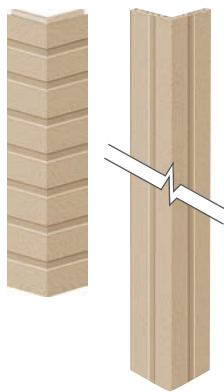

FACTORY STANDARD COLORS

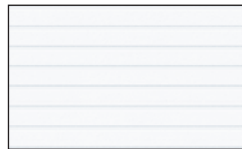

Arctic White
HFH9131U

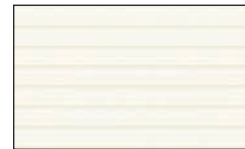

Pearl
HFH9132U

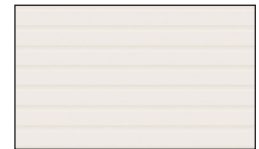

Silk
HFH9133U

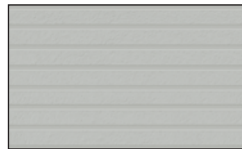

Silver Gray
HFH9134U



Mid Gray
HFH9135U



Dusky Gray
HFH9136U



Slate
HFH9137U



Charcoal
HFH9138U

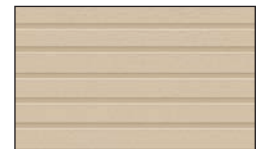

Wheat
HFH9139U

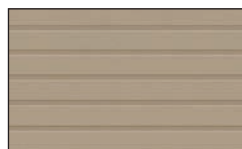

Brass
HFH91310U



Willow Gray
HFH91316U



Saffron
HFH91312U



Blue Gray
HFH91317U

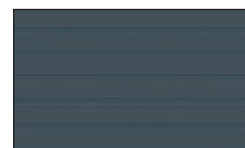

Midnight Blue
HFH91314U

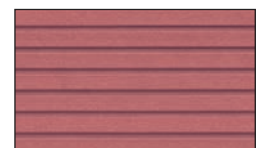

Sienna Blush
HFH91318U

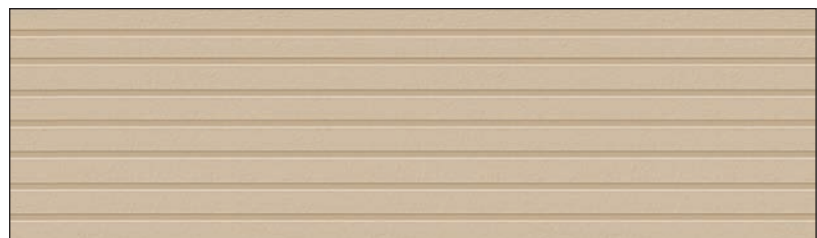

Wheat | HFH9139U

BASIC SPECIFICATIONS	
Panel Type	Solid-Core
Application Method	Vertical or Horizontal
Joint Type	Caulk Free
Coating Options	Triple Coated (15 colors) Creativ™ Custom Colors
Dimensions (Nominal)	W: 18" (455 mm) L: 10' (3030 mm) T: 5/8" (16 mm)
Coverage	15 ft ² (1.38 m ²)
Weight	55 lb. (25 kg)
The Triple Coating is super weather resistant, low maintenance, and backed by a 20-year fade limited warranty.	
Please visit our website for additional CERACLAD product information including: <ul style="list-style-type: none"> • Product samples • Custom color samples • Specifications • CAD details • Product performance and approval documents • MSDS 	

1. The product color tones on this sheet may appear slightly different from the actual products. Final color selection should be made from product samples.
2. Colors and textures are subject to change.
3. Damage caused by any product installation, repair, or replacement that is not in accordance with KMEW's technical manual, as well as damage caused by product installation on inappropriate buildings/structures, is specifically excluded from warranty coverage. Please review KMEW's technical manual and website for this product.

CERACLAD® Triple Coated
Fiber-Cement Siding Caulk-Free
Rainscreen System

20-Year Fade Limited Warranty • 365 Days Self-Cleaning • Low Maintenance

CREATIV® custom color program is available in this texture. Custom color samples can be requested at: ceraclad.com/creativ-custom-color

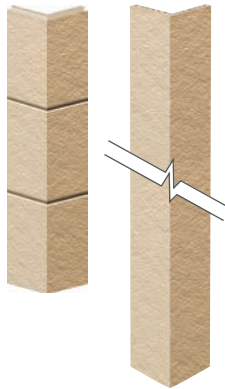

BASIC SPECIFICATIONS	
Panel Type	Solid-Core
Application Method	Vertical or Horizontal
Joint Type	Caulk Free
Coating Options	Triple Coated (15 colors) Creativ™ Custom Colors
Dimensions (Nominal)	W: 18" (455 mm) L: 10' (3030 mm) T: 5/8" (16 mm)
Coverage	15 ft ² (1.38 m ²)
Weight	55 lb. (25 kg)
The Triple Coating is super weather resistant, low maintenance, and backed by a 20-year fade limited warranty.	
Please visit our website for additional CERACLAD product information including: <ul style="list-style-type: none"> • Product samples • Custom color samples • Specifications • CAD details • Product performance and approval documents • MSDS 	

FACTORY STANDARD COLORS



Arctic White
HFH9191A



Pearl
HFH9192A

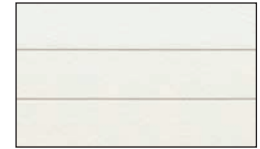

Silk
HFH9193A



Silver Gray
HFH9194A



Mid Gray
HFH9195A

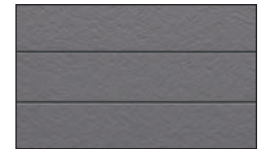

Dusky Gray
HFH9196A

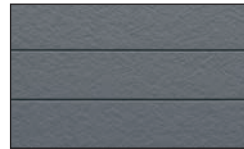

Slate
HFH9197A



Charcoal
HFH9198A

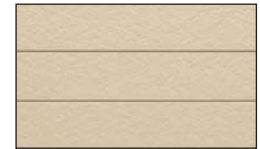

Wheat
HFH9199A

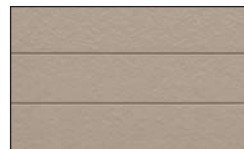

Brass
HFH91910A

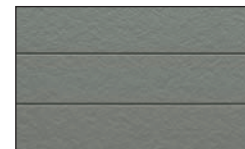

Willow Gray
HFH91916A

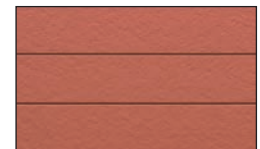

Saffron
HFH91912A

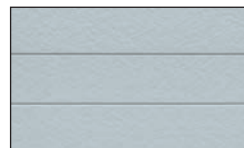

Blue Gray
HFH91917A

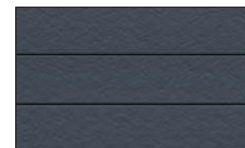

Midnight Blue
HFH91914A

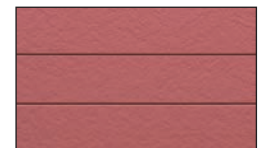

Sienna Blush
HFH91918A

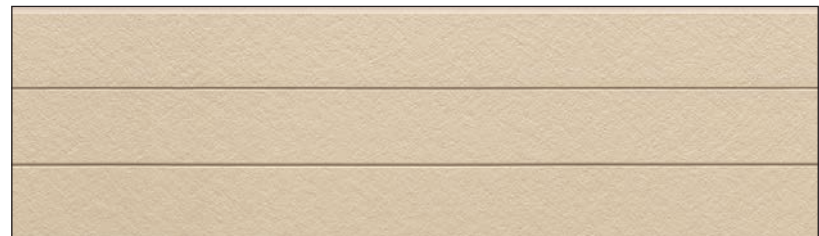

Wheat | HFH9199A

1. The product color tones on this sheet may appear slightly different from the actual products. Final color selection should be made from product samples.
2. Colors and textures are subject to change.
3. Damage caused by any product installation, repair, or replacement that is not in accordance with KMEW's technical manual, as well as damage caused by product installation on inappropriate buildings/structures, is specifically excluded from warranty coverage. Please review KMEW's technical manual and website for this product.

CERACLAD® Triple Coated
Fiber-Cement Siding Caulk-Free
 Rainscreen System

20-Year Fade Limited Warranty • 365 Days Self Cleaning • Low Maintenance

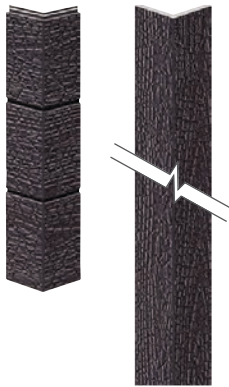

Deep Charred
 HFH5481U



Light Charred
 HFH5491U

BASIC SPECIFICATIONS	
Panel Type	Solid-Core
Application Method	Vertical or Horizontal
Joint Type	Caulk Free
Coating Options	Triple Coated (2 colors)
Dimensions (Nominal)	W: 18" (455 mm) L: 10' (3030 mm) T: 5/8" (16 mm)
Coverage	15 ft ² (1.38 m ²)
Weight	52 lb. (23.4 kg)
The Triple Coating is super weather resistant, low maintenance, and backed by a 20-year fade limited warranty.	
Please visit our website for additional CERACLAD product information including: <ul style="list-style-type: none"> • Product samples • Custom color samples • Specifications • CAD details • Product performance and approval documents • MSDS 	



Light Charred | HFH5491U

1. The product color tones on this sheet may appear slightly different from the actual products. Final color selection should be made from product samples.
2. Colors and textures are subject to change.
3. Damage caused by any product installation, repair, or replacement that is not in accordance with KMEW's technical manual, as well as damage caused by product installation on inappropriate buildings/structures, is specifically excluded from warranty coverage. Please review KMEW's technical manual and website for this product.

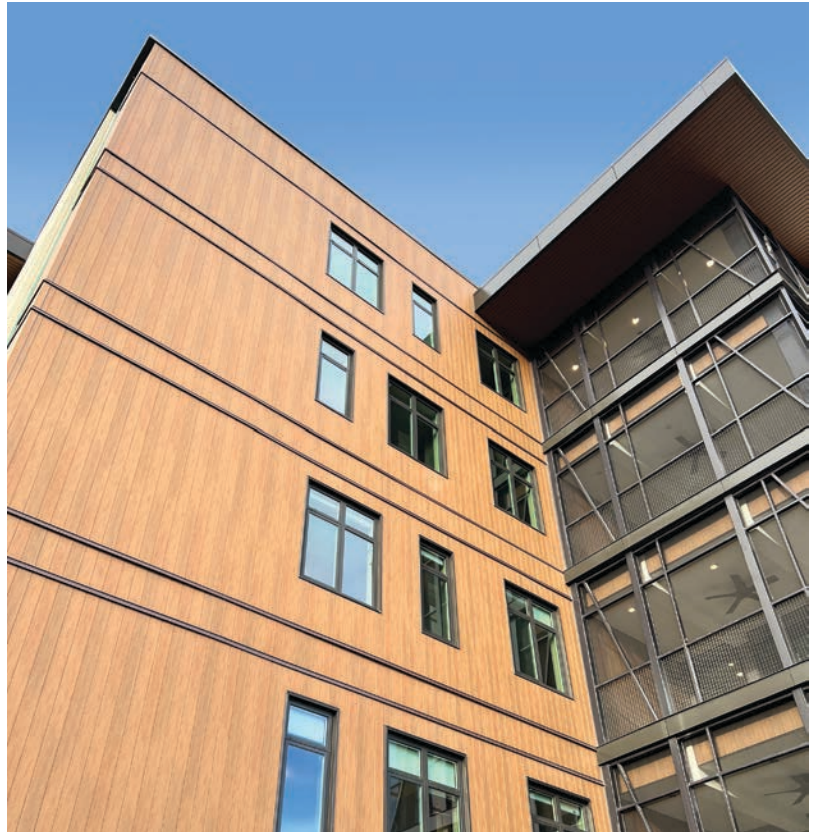

CERACLAD® Triple Coated
Fiber-Cement Caulk-Free
Siding Rainscreen System

20-Year Fade Limited Warranty • 365 Days Self Cleaning • Low Maintenance

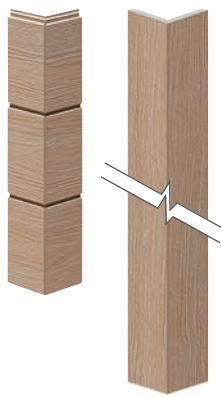

Honey
HFH7452U



Cappuccino
HFH7451U



Espresso
HFH7454U



Golden Brown
HFH7453U



Ash
HFH7455U

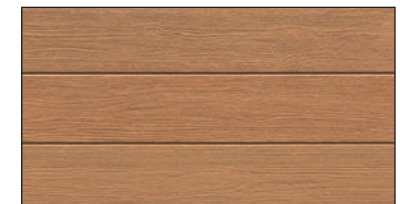

Harvest Glow
HFH7456U

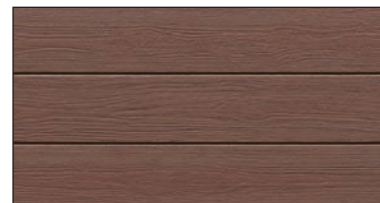

Chestnut Haze
HFH7457U

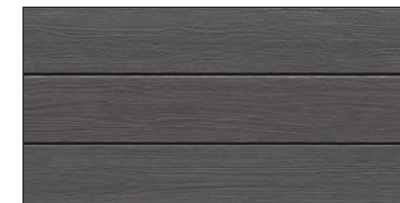

Urban Slate
HFH7458U



Ash | HFH7455U

BASIC SPECIFICATIONS	
Panel Type	Solid-Core
Application Method	Vertical or Horizontal
Joint Type	Caulk Free
Coating Options	Triple Coated (8 colors)
Dimensions (Nominal)	W: 18" (455 mm) L: 10' (3030 mm) T: 5/8" (16 mm)
Coverage	15 ft ² (1.38 m ²)
Weight	55 lb. (25 kg)
The Triple Coating is super weather resistant, low maintenance, and backed by a 20-year fade limited warranty.	
Please visit our website for additional CERACLAD product information including: <ul style="list-style-type: none"> • Product samples • Custom color samples • Specifications • CAD details • Product performance and approval documents • MSDS 	

1. The product color tones on this sheet may appear slightly different from the actual products. Final color selection should be made from product samples.
2. Colors and textures are subject to change.
3. Damage caused by any product installation, repair, or replacement that is not in accordance with KMEW's technical manual, as well as damage caused by product installation on inappropriate buildings/structures, is specifically excluded from warranty coverage. Please review KMEW's technical manual and website for this product.



CERACLAD® Triple Coated
Fiber-Cement Siding Caulk-Free
 Rainscreen System

20-Year Fade Limited Warranty • 365 Days Self Cleaning • Low Maintenance

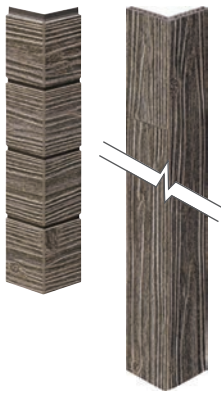

Almond
FH4879U



White
FH48710U



Coffee
FH4878U



Charcoal
FH48712U



Caramel
FH4875U



Gray
FH48713U



Coffee | FH4878U

BASIC SPECIFICATIONS	
Panel Type	Solid-Core
Application Method	Vertical or Horizontal
Joint Type	Caulk Free
Coating Options	Triple Coated (6 colors)
Dimensions (Nominal)	W: 18" (455 mm) L: 10' (3030 mm) T: 5/8" (16 mm)
Coverage	15 ft ² (1.38 m ²)
Weight	55 lb. (25 kg)
The Triple Coating is super weather resistant, low maintenance, and backed by a 20-year fade limited warranty.	
Please visit our website for additional CERACLAD product information including: <ul style="list-style-type: none"> • Product samples • Custom color samples • Specifications • CAD details • Product performance and approval documents • MSDS 	

1. The product color tones on this sheet may appear slightly different from the actual products. Final color selection should be made from product samples.
2. Colors and textures are subject to change.
3. Damage caused by any product installation, repair, or replacement that is not in accordance with KMEW's technical manual, as well as damage caused by product installation on inappropriate buildings/structures, is specifically excluded from warranty coverage. Please review KMEW's technical manual and website for this product.

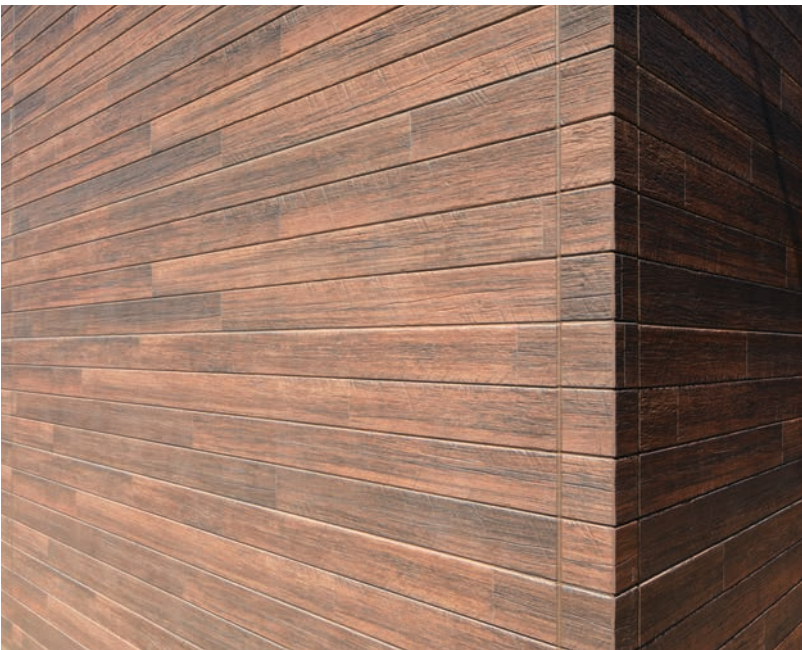

Antique Sawn

CERACLAD® Triple Coated Fiber-Cement Siding | Caulk-Free Rainscreen System

20-Year Fade Limited Warranty • 365 Days Self Cleaning • Low Maintenance

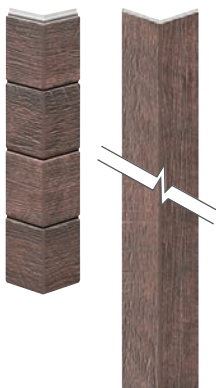

Ash
FH7261A



Amber
FH7263A



Reddish Brown
FH7265A



Reddish Brown | FH7265A

BASIC SPECIFICATIONS

Panel Type	Solid-Core
Application Method	Vertical or Horizontal
Joint Type	Caulk Free
Coating Options	Triple Coated (3 colors)
Dimensions (Nominal)	W: 18" (455 mm) L: 10' (3030 mm) T: 5/8" (16 mm)
Coverage	15 ft ² (1.38 m ²)
Weight	55 lb. (25 kg)

The Triple Coating is super weather resistant, low maintenance, and backed by a 20-year fade limited warranty.

Please visit our website for additional CERACLAD product information including:

- Product samples
- Custom color samples
- Specifications
- CAD details
- Product performance and approval documents
- MSDS

1. The product color tones on this sheet may appear slightly different from the actual products. Final color selection should be made from product samples.
2. Colors and textures are subject to change.
3. Damage caused by any product installation, repair, or replacement that is not in accordance with KMEW's technical manual, as well as damage caused by product installation on inappropriate buildings/structures, is specifically excluded from warranty coverage. Please review KMEW's technical manual and website for this product.



CERACLAD® Triple Coated
Fiber-Cement Siding Caulk-Free
Rainscreen System

20-Year Fade Limited Warranty • 365 Days Self Cleaning • Low Maintenance

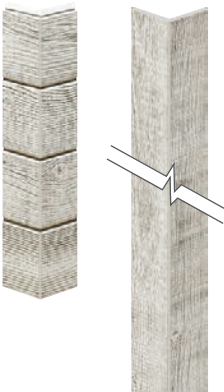

Ash
 HFH7521A



Mahogany
 HFH7524A



Brown
 HFH7522A



Light Oak
 HFH7526A



Black
 HFH7523A



Light Oak | HFH7526A

BASIC SPECIFICATIONS	
Panel Type	Solid-Core
Application Method	Vertical or Horizontal
Joint Type	Caulk Free
Coating Options	Triple Coated (5 colors)
Dimensions (Nominal)	W: 18" (455 mm) L: 10' (3030 mm) T: 5/8" (16 mm)
Coverage	15 ft ² (1.38 m ²)
Weight	55 lb. (25 kg)
The Triple Coating is super weather resistant, low maintenance, and backed by a 20-year fade limited warranty.	
Please visit our website for additional CERACLAD product information including: <ul style="list-style-type: none"> • Product samples • Custom color samples • Specifications • CAD details • Product performance and approval documents • MSDS 	

1. The product color tones on this sheet may appear slightly different from the actual products. Final color selection should be made from product samples.
2. Colors and textures are subject to change.
3. Damage caused by any product installation, repair, or replacement that is not in accordance with KMEW's technical manual, as well as damage caused by product installation on inappropriate buildings/structures, is specifically excluded from warranty coverage. Please review KMEW's technical manual and website for this product.

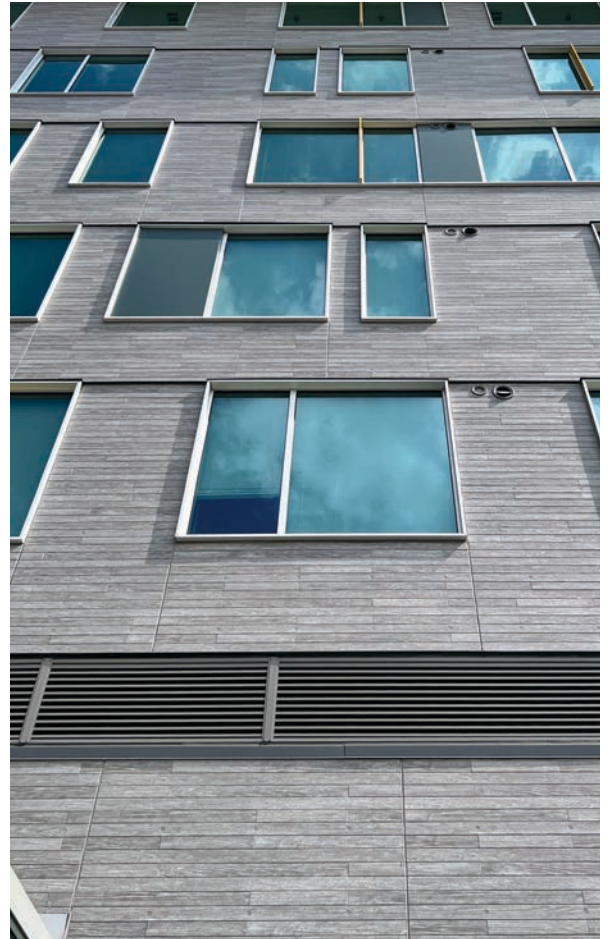

Board Formed Concrete

CERACLAD® Triple Coated Fiber-Cement Siding Caulk-Free Rainscreen System

20-Year Fade Limited Warranty • 365 Days Self Cleaning • Low Maintenance



Close-up of texture

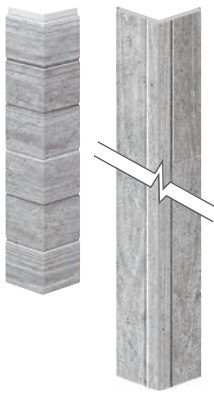

Concrete Gray
HFH7431A



Warm Gray
HFH7432A



Fog Gray
HFH7433A



Concrete Gray | HFH7431A

BASIC SPECIFICATIONS

Panel Type	Solid-Core
Application Method	Vertical or Horizontal
Joint Type	Caulk Free
Coating Options	Triple Coated (3 colors)
Dimensions (Nominal)	W: 18" (455 mm) L: 10' (3030 mm) T: 5/8" (16 mm)
Coverage	15 ft ² (1.38 m ²)
Weight	60 lb. (27 kg)

The Triple Coating is super weather resistant, low maintenance, and backed by a 20-year fade limited warranty.

Please visit our website for additional CERACLAD product information including:

- Product samples
- Custom color samples
- Specifications
- CAD details
- Product performance and approval documents
- MSDS

1. The product color tones on this sheet may appear slightly different from the actual products. Final color selection should be made from product samples.
2. Colors and textures are subject to change.
3. Damage caused by any product installation, repair, or replacement that is not in accordance with KMEW's technical manual, as well as damage caused by product installation on inappropriate buildings/structures, is specifically excluded from warranty coverage. Please review KMEW's technical manual and website for this product.

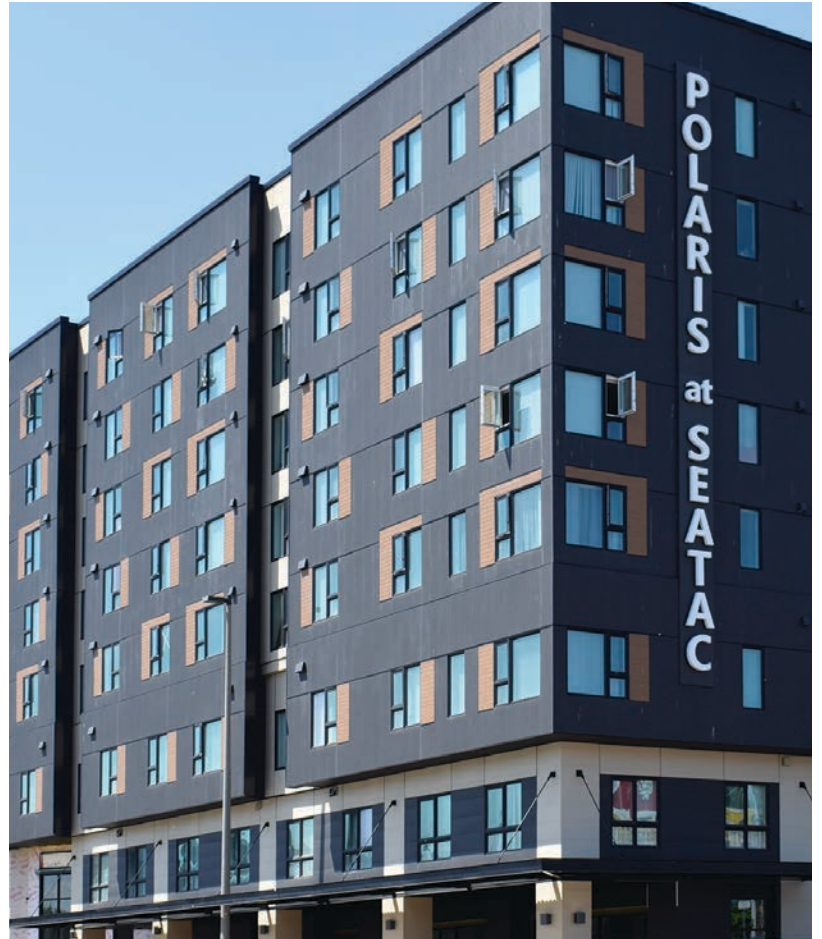

CERACLAD® Triple Coated
Fiber-Cement Siding | Caulk-Free
Rainscreen System

20-Year Fade Limited Warranty • 365 Days Self Cleaning • Low Maintenance

CREATIV® custom color program is available in this texture. Custom color samples can be requested at: ceraclad.com/creativ-custom-color

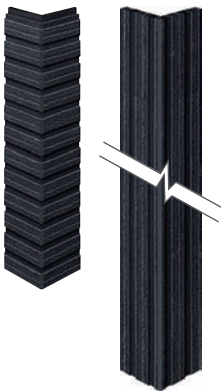

Pearl
 HFH7461U



Ash
 HFH7462U



Charcoal
 HFH7463U



Mid Gray
 HFH7464U

BASIC SPECIFICATIONS	
Panel Type	Solid-Core
Application Method	Vertical or Horizontal
Joint Type	Caulk Free
Coating Options	Triple Coated (4 colors) Creativ™ Custom Colors
Dimensions (Nominal)	W: 18" (455 mm) L: 10' (3030 mm) T: 5/8" (16 mm)
Coverage	15 ft ² (1.38 m ²)
Weight	55 lb. (25 kg)
The Triple Coating is super weather resistant, low maintenance, and backed by a 20-year fade limited warranty.	
Please visit our website for additional CERACLAD product information including: <ul style="list-style-type: none"> • Product samples • Custom color samples • Specifications • CAD details • Product performance and approval documents • MSDS 	



Charcoal | HFH7463U

1. The product color tones on this sheet may appear slightly different from the actual products. Final color selection should be made from product samples.
2. Colors and textures are subject to change.
3. Damage caused by any product installation, repair, or replacement that is not in accordance with KMEW's technical manual, as well as damage caused by product installation on inappropriate buildings/structures, is specifically excluded from warranty coverage. Please review KMEW's technical manual and website for this product.



CERACLAD® Triple Coated
Fiber-Cement Siding Caulk-Free
Rainscreen System

20-Year Fade Limited Warranty • 365 Days Self Cleaning • Low Maintenance

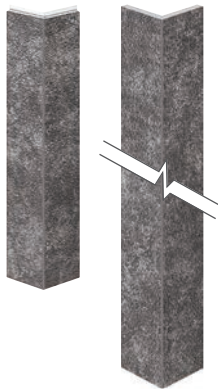

Ashlar Slate
FH7272A

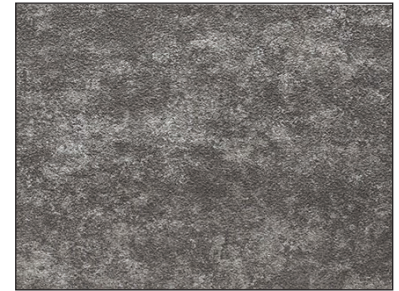

Blacken Steel
FH7275A



Corten Steel
FH7276A



Walnut
FH7278A



Exposed Aggregate
FH7277A

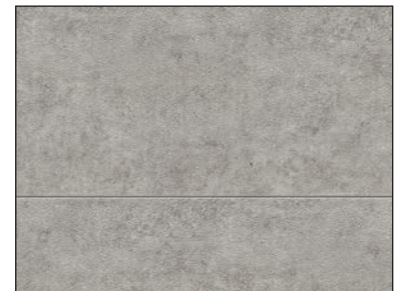

Weathered Concrete
FH7279A

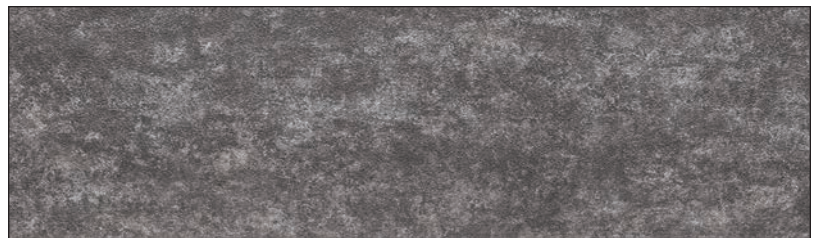

Blacken Steel | FH7275A

BASIC SPECIFICATIONS	
Panel Type	Solid-Core
Application Method	Vertical or Horizontal
Joint Type	Caulk Free
Coating Options	Triple Coated (6 colors)
Dimensions (Nominal)	W: 18" (455 mm) L: 10' (3030 mm) T: 5/8" (16 mm)
Coverage	15 ft ² (1.38 m ²)
Weight	58 lb. (26 kg)
The Triple Coating is super weather resistant, low maintenance, and backed by a 20-year fade limited warranty.	
Please visit our website for additional CERACLAD product information including: <ul style="list-style-type: none"> • Product samples • Custom color samples • Specifications • CAD details • Product performance and approval documents • MSDS 	

1. The product color tones on this sheet may appear slightly different from the actual products. Final color selection should be made from product samples.
2. Colors and textures are subject to change.
3. Damage caused by any product installation, repair, or replacement that is not in accordance with KMEW's technical manual, as well as damage caused by product installation on inappropriate buildings/structures, is specifically excluded from warranty coverage. Please review KMEW's technical manual and website for this product.

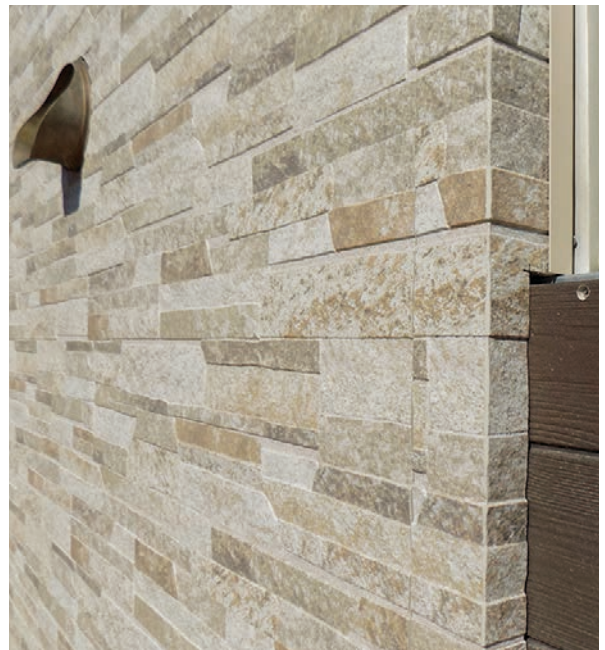

CERACLAD® Triple Coated
Fiber-Cement Siding Caulk-Free
Rainscreen System

20-Year Fade Limited Warranty • 365 Days Self Cleaning • Low Maintenance

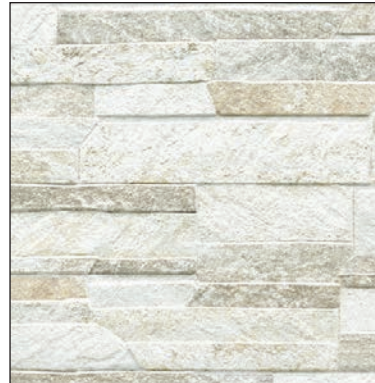

White
 FH7251A



Brown
 FH7252A



Gray
 FH7253A

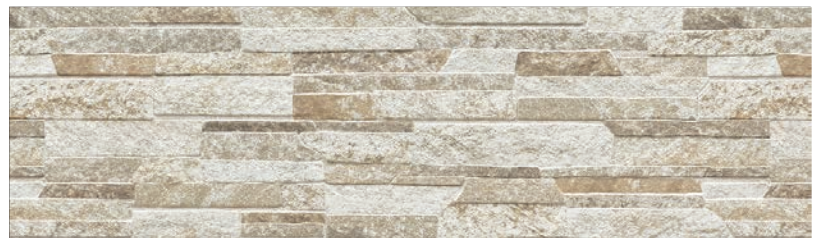

Brown | FH7252A

BASIC SPECIFICATIONS	
Panel Type	Solid-Core
Application Method	Horizontal
Joint Type	Caulk Free
Coating Options	Triple Coated (3 colors)
Dimensions (Nominal)	W: 18" (455 mm) L: 10' (3030 mm) T: 5/8" (16 mm)
Coverage	15 ft ² (1.38 m ²)
Weight	58 lb. (26 kg)
The Triple Coating is super weather resistant, low maintenance, and backed by a 20-year fade limited warranty.	
Please visit our website for additional CERACLAD product information including: <ul style="list-style-type: none"> • Product samples • Custom color samples • Specifications • CAD details • Product performance and approval documents • MSDS 	

1. The product color tones on this sheet may appear slightly different from the actual products. Final color selection should be made from product samples.
2. Colors and textures are subject to change.
3. Damage caused by any product installation, repair, or replacement that is not in accordance with KMEW's technical manual, as well as damage caused by product installation on inappropriate buildings/structures, is specifically excluded from warranty coverage. Please review KMEW's technical manual and website for this product.



White
FH4925U



Orange
FH4927U



Red
FH4928U



Gray
HFH49251U



Petina Brown
HFH49252U



CERA CLAD® Triple Coated
Fiber-Cement Siding | Caulk-Free
Rainscreen System

20-Year Fade Limited Warranty • 365 Days Self Cleaning • Low Maintenance

BASIC SPECIFICATIONS

Panel Type	Solid-Core
Application Method	Horizontal
Joint Type	Caulk Free
Coating Options	Triple Coated (4 colors)
Dimensions (Nominal)	W: 18" (455 mm) L: 10' (3030 mm) T: 5/8" (16 mm)
Coverage	15 ft ² (1.38 m ²)
Weight	55 lb. (25 kg)

The Triple Coating is super weather resistant, low maintenance, and backed by a 20-year fade limited warranty.

Please visit our website for additional **CERA CLAD** product information including:

- Product samples
- Custom color samples
- Specifications
- CAD details
- Product performance and approval documents
- MSDS

1. The product color tones on this sheet may appear slightly different from the actual products. Final color selection should be made from product samples.
2. Colors and textures are subject to change.
3. Damage caused by any product installation, repair, or replacement that is not in accordance with KMEW's technical manual, as well as damage caused by product installation on inappropriate buildings/structures, is specifically excluded from warranty coverage. Please review KMEW's technical manual and website for this product.



Gray
FH7156A



Red
FH7157A



White
FH7155A



Black
FH7158A



CERA CLAD® Triple Coated
Fiber-Cement Siding Caulk-Free
Rainscreen System

20-Year Fade Limited Warranty • 365 Days Self Cleaning • Low Maintenance

BASIC SPECIFICATIONS	
Panel Type	Solid-Core
Application Method	Horizontal
Joint Type	Caulk Free
Coating Options	Triple Coated (4 colors)
Dimensions (Nominal)	W: 18" (455 mm) L: 10' (3030 mm) T: 5/8" (16 mm)
Coverage	15 ft ² (1.38 m ²)
Weight	51 lb. (23 kg)
The Triple Coating is super weather resistant, low maintenance, and backed by a 20-year fade limited warranty.	
Please visit our website for additional CERA CLAD product information including: <ul style="list-style-type: none"> • Product samples • Custom color samples • Specifications • CAD details • Product performance and approval documents • MSDS 	

1. The product color tones on this sheet may appear slightly different from the actual products. Final color selection should be made from product samples.
2. Colors and textures are subject to change.
3. Damage caused by any product installation, repair, or replacement that is not in accordance with KMEW's technical manual, as well as damage caused by product installation on inappropriate buildings/structures, is specifically excluded from warranty coverage. Please review KMEW's technical manual and website for this product.



CERA CLAD® Triple Coated
Fiber-Cement Siding Caulk-Free
Rainscreen System

20-Year Fade Limited Warranty • 365 Days Self Cleaning • Low Maintenance



Pearl
FH4895U



Cream
FH4896U



Charcoal
FH4898U

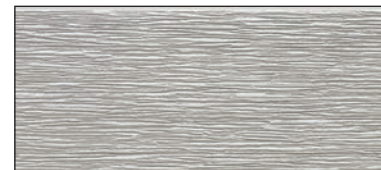

Gray
FH4899U



BASIC SPECIFICATIONS

Panel Type	Solid-Core
Application Method	Vertical or Horizontal
Joint Type	Caulk Free
Coating Options	Triple Coated (4 colors)
Dimensions (Nominal)	W: 18" (455 mm) L: 10' (3030 mm) T: 5/8" (16 mm)
Coverage	15 ft ² (1.38 m ²)
Weight	55 lb. (25 kg)

The Triple Coating is super weather resistant, low maintenance, and backed by a 20-year fade limited warranty.

Please visit our website for additional **CERA CLAD** product information including:

- Product samples
- Custom color samples
- Specifications
- CAD details
- Product performance and approval documents
- MSDS

1. The product color tones on this sheet may appear slightly different from the actual products. Final color selection should be made from product samples.
2. Colors and textures are subject to change.
3. Damage caused by any product installation, repair, or replacement that is not in accordance with KMEW's technical manual, as well as damage caused by product installation on inappropriate buildings/structures, is specifically excluded from warranty coverage. Please review KMEW's technical manual and website for this product.

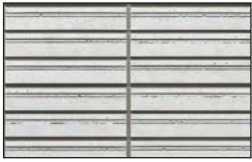

Gray
FH7141A



Dark Brown
FH7144A



Yellow
FH7142A



White
FH7145A



Red
FH7143A

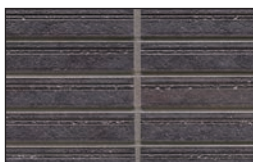

Black
FH7146A



CERA CLAD® Triple Coated
Fiber-Cement Siding Caulk-Free
Rainscreen System

20-Year Fade Limited Warranty • 365 Days Self Cleaning • Low Maintenance

BASIC SPECIFICATIONS

Panel Type	Solid-Core
Application Method	Horizontal
Joint Type	Caulk Free
Coating Options	Triple Coated (6 colors)
Dimensions (Nominal)	W: 18" (455 mm) L: 10' (3030 mm) T: 5/8" (16 mm)
Coverage	15 ft ² (1.38 m ²)
Weight	55 lb. (25 kg)

The Triple Coating is super weather resistant, low maintenance, and backed by a 20-year fade limited warranty.

Please visit our website for additional **CERA CLAD** product information including:

- Product samples
- Custom color samples
- Specifications
- CAD details
- Product performance and approval documents
- MSDS

1. The product color tones on this sheet may appear slightly different from the actual products. Final color selection should be made from product samples.
2. Colors and textures are subject to change.
3. Damage caused by any product installation, repair, or replacement that is not in accordance with KMEW's technical manual, as well as damage caused by product installation on inappropriate buildings/structures, is specifically excluded from warranty coverage. Please review KMEW's technical manual and website for this product.



CERA CLAD® Triple Coated
Fiber-Cement Siding Caulk-Free
Rainscreen System

20-Year Fade Limited Warranty • 365 Days Self Cleaning • Low Maintenance



White
FH7131U



Gray
FH7132U



Blue
FH7133U



Black
FH7134U



BASIC SPECIFICATIONS

Panel Type	Solid-Core
Application Method	Horizontal
Joint Type	Caulk Free
Coating Options	Triple Coated (4 colors)
Dimensions (Nominal)	W: 18" (455 mm) L: 10' (3030 mm) T: 5/8" (16 mm)
Coverage	15 ft ² (1.38 m ²)
Weight	55 lb. (25 kg)

The Triple Coating is super weather resistant, low maintenance, and backed by a 20-year fade limited warranty.

Please visit our website for additional **CERA CLAD** product information including:

- Product samples
- Custom color samples
- Specifications
- CAD details
- Product performance and approval documents
- MSDS

1. The product color tones on this sheet may appear slightly different from the actual products. Final color selection should be made from product samples.
2. Colors and textures are subject to change.
3. Damage caused by any product installation, repair, or replacement that is not in accordance with KMEW's technical manual, as well as damage caused by product installation on inappropriate buildings/structures, is specifically excluded from warranty coverage. Please review KMEW's technical manual and website for this product.

CERACLAD® Triple Coated
Fiber-Cement Siding Caulk-Free
 Rainscreen System

20-Year Fade Limited Warranty • 365 Days Self Cleaning • Low Maintenance



Arctic White
FH7171K



Silk
FH7172K



Beige
FH7173K

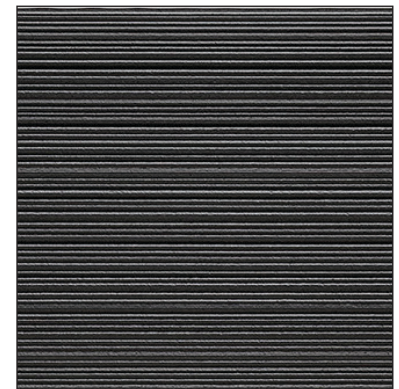

Black
FH7175K

BASIC SPECIFICATIONS	
Panel Type	Solid-Core
Application Method	Horizontal
Joint Type	Caulk Free
Coating Options	Triple Coated (4 colors)
Dimensions (Nominal)	W: 18" (455 mm) L: 10' (3030 mm) T: 5/8" (16 mm)
Coverage	15 ft ² (1.38 m ²)
Weight	55 lb. (25 kg)
The Triple Coating is super weather resistant, low maintenance, and backed by a 20-year fade limited warranty.	
Please visit our website for additional CERACLAD product information including: <ul style="list-style-type: none"> • Product samples • Custom color samples • Specifications • CAD details • Product performance and approval documents • MSDS 	



Silk | FH7172K

1. The product color tones on this sheet may appear slightly different from the actual products. Final color selection should be made from product samples.
2. Colors and textures are subject to change.
3. Damage caused by any product installation, repair, or replacement that is not in accordance with KMEW's technical manual, as well as damage caused by product installation on inappropriate buildings/structures, is specifically excluded from warranty coverage. Please review KMEW's technical manual and website for this product.

PRODUCT AND FINISH WARRANTY

CERAMIC COATING

30 YEARS Product	20 YEARS Color-Fade
WARRANTY	

CERACLAD's inorganic ceramic coating has excellent UV blocking properties to protect the color layer from ultraviolet rays and minimize fading of the outer wall. Maintenance costs are reduced by virtually eliminating the need for repainting. This technology is exclusive to CERACLAD.

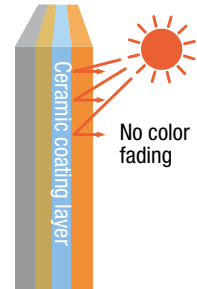

20-Year Fade Limited Warranty



Meticulous Quality Checks Performed by Skilled Workers

Even in automated manufacturing, we have skilled workers perform visual and assembly inspections where quality should be checked thoroughly. This process ensures high-quality production in a fast-paced environment.



RAINSCREEN MOISTURE MANAGEMENT

CERACLAD's Rainscreen Moisture Management System is an advanced wall assembly that incorporates proven rain-shielding technology. The system consists of pre-finished siding panels and innovative mounting clips and accessories that are manufactured and designed for durability and ease of installation.

Our exclusive technology combines a durable weather-resistant exterior with an internal ventilation layer that allows moisture to escape.

- Moisture management
- Air cavity
- Air flow
- Helps to prevent mold from growing

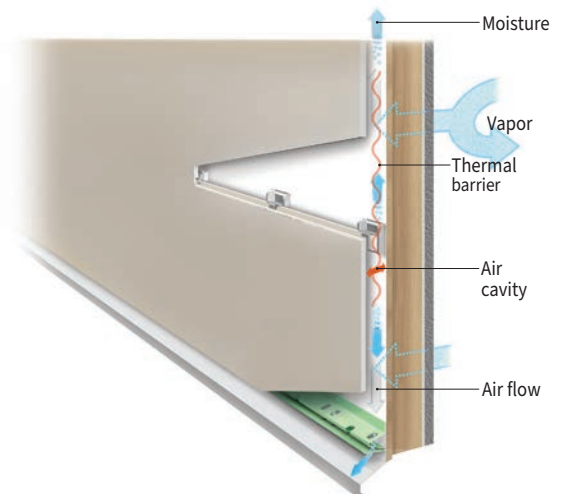

CLEAR PRICING PACKAGE

We have a clear pricing system with one-size, one-price, and one-stop shopping. Off-site fabrication/shop drawings are not required. Moreover, our Caulk-Free Installation System reduces cost and time. In addition, our color warranty and self-cleaning function minimize the maintenance cost and optimize the return on investment for customers.

COST AND VALUE COMPARISON CHART				
High-end	HPC Terracotta Hi-Density Fiber Cement Phenolic Panels 10 yr None	ACM 25 yr None		EUROPEAN Design-Focused
Mid-range		Mid-Density Fiber Cement 15 yr None	 Triple-Coated Panels 30 yr Product Warranty 20 yr Color Fade Warranty	JAPANESE Quality and Design-Focused
Low-end	3-Coat Stucco None None	Pre-Finished Sheet Panel Pre-Finished Lap Siding 15 yr 3 yr		AMERICAN Price-Focused
PRICE RANGE	0 – 10 Years		15 – 25 Years	30 Years
	Product Warranty Length			
	Color Fade Warranty Length			
				PRODUCT FEATURE

This information is for reference only as of April 1, 2024, and may not accurately reflect the actual price.

ECO-FRIENDLY PANELS

Our panels are crafted using approximately 45% recycled materials. We provide independently verified Health Product Declaration (HPD) and Environmental Product Declaration (EPD) statements, ensuring our products are eco-friendly and contribute positively to the local community.



EPD Number: HUB-1313
 Manufacture: KMEW
 Validity Period: April 19, 2024 to April 19, 2029



COMPANY AND PRODUCT INFO

Issued to	KMEW
For the Products	KMEW Siding
Description	The KMEW Siding system provides a long lasting, energy and resource efficient cladding solution. Consisting of approximately 45% recycled content, the cladding panels are 100% recyclable at end of life, provide a factory finish with no VOC and are available in a multitude of texture and color choices.

Soffit Design and Installation Standards

DETAIL DRAWING - HORIZONTAL APPLICATION

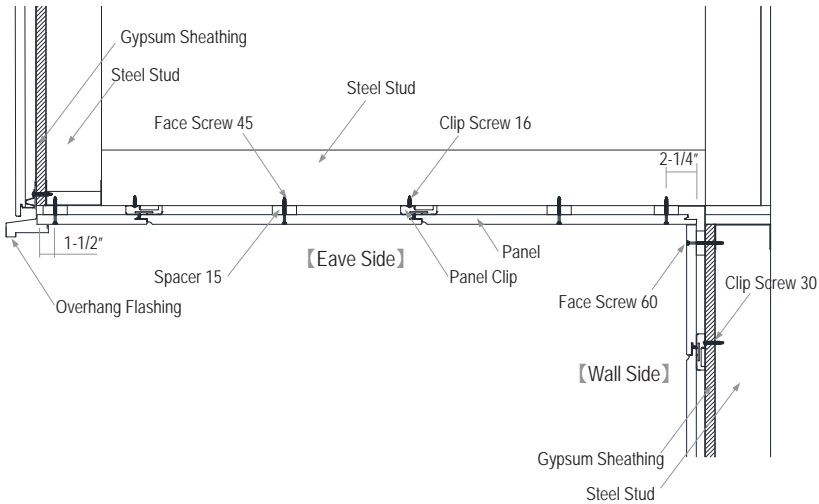

SCOPE

Item	Scope
Structure	Wood, Steel
Applicable portion	Eave • The construction surface must be flat. • Both sloped and horizontal eaves are acceptable
Target Products	All CERACLAD products
Design Pressure	Equivalent to CERACLAD for exterior wall – see ESR 1627
Application method	Vertical or Horizontal
Fixing method	① Panel clip + Face screw ② Long clip + Face screw

SUBSTRATE STANDARDS

		Wood	Steel
Stud	Way to construct	Perpendicular to the direction of panel installation	
	Interval	16" (400mm) or less	
	Dimension	2' x 4", 2' x 6"	3-5/8" x 1-5/8" 18GA~16GA
	reinforcement	Appropriate implementation under the responsibility of the project engineer. (The substrate must be constructed to support the weight of the panels.)	
Sheathing	None		None
	Plywood/OSB (1/2")		Glass Mat Gypsum (t 5/8")
	Plywood/OSB (1/2") +Glass Mat Gypsum (5/8")		Glass Mat Gypsum (t 5/8") x 2
Substrate Flatness	2mm or less		
Ensure ventilation of walls	Appropriate implementation under the responsibility of the project engineer.		

CORNER SECTION - DIAGONAL INSTALLATION

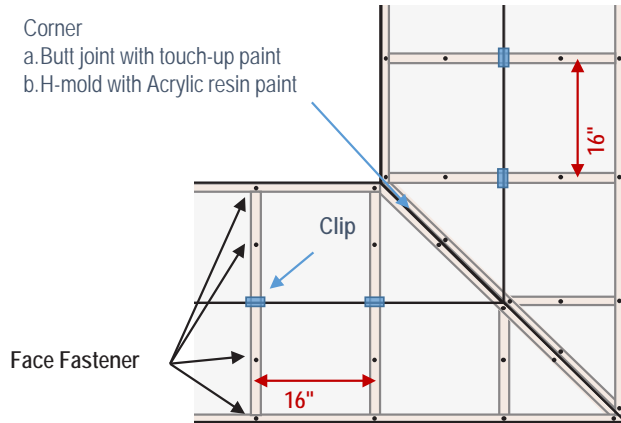

PANEL INSTALLATION STANDARDS

Structure	Sheathing	Screw (Product No)	
		For panel clip	For face fastener
Wood	None	(B881135)	(B885245)
	Plywood/OSB (1/2")	(B881135)	(B885260)
	Plywood/OSB (1/2") +Glass Mat Gypsum (5/8")	(B88553)	Purchase locally
Steel	None	(B885116)	(B885245)
	Glass Mat Gypsum (5/8")	(B885130)	(B885260)
	Glass Mat Gypsum (5/8") x 2	Purchase locally	Purchase locally

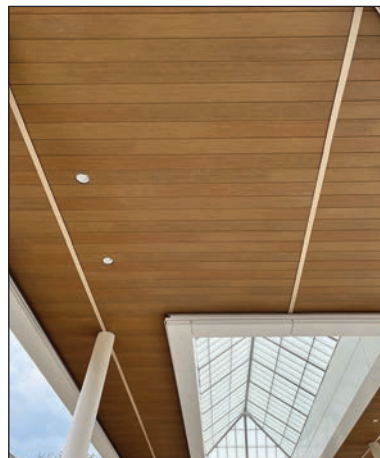
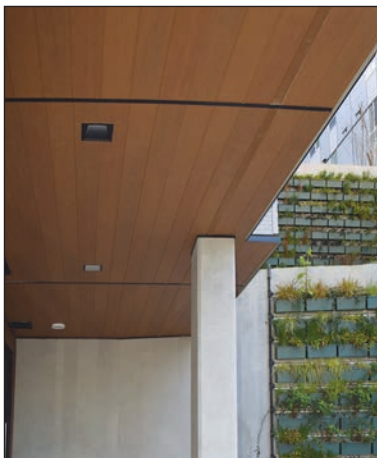

Caulk-Free & Accessories

CERACLAD's T-jointer and L-jointer Eliminate the Need for Caulking, Achieving a Clean Sleek Surface in a More Economical Way

Caulk-Free T-joint



Conventional Caulk Joint





CERACLAD T-Joint Installation Quick Guide

Install the T-jointer butted to the panel and secure with screws every 16" o.c.; Install the panel clip so it does not overlap the T-jointer.

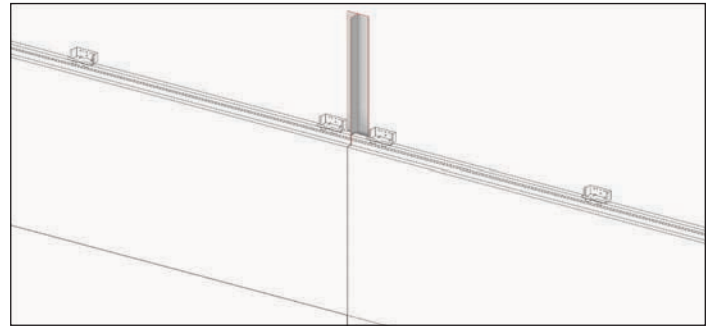
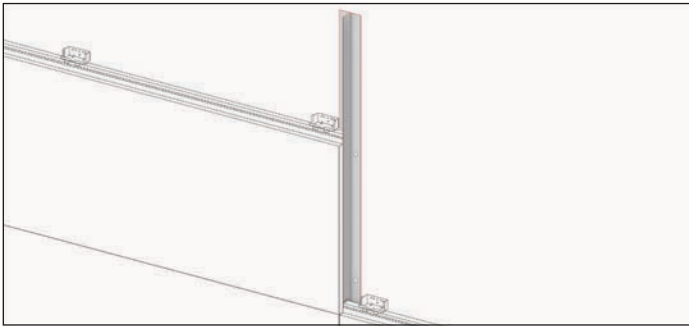
Continue to install panels butted to T-joint, fasten clips and repeat.



Installation Accessories

Panel Clip	Corner Clip	Starter Bar	T-Joiner	Gasket Joiner
				
Wood/Steel Screw	Touch-up Paint	Spacer Block	Saw Blade	Waterproof Sealer
				

CERACLAD's New Trim Options Build Your Full Package in a More Economical Way

Fry Reglet Trim Manufactured for Ceraclad

Trim Information:

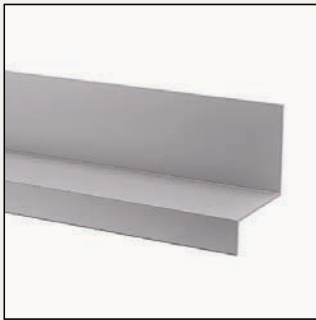

Through Wall Flash 1 - 1/2"



Through Wall Flash 2 Piece
1 - 1/2"

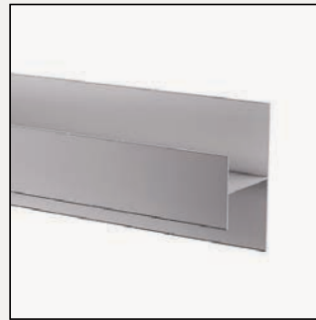

H Mold 1 - 1/4"



H Mold 2 Piece 1 - 1/4"



J Trim 1 - 1/4"



J Trim 2 Piece 1 - 1/4"



L Joiner 1 - 1/4"



U Mold 2 Piece 1 - 1/4"

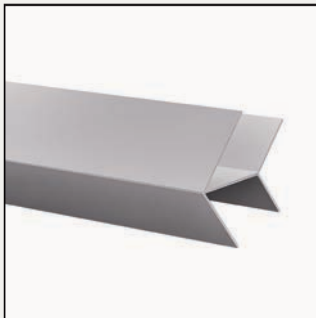

Arrow Outer Corner -1 - 1/4"



Arrow Outer Corner 2 Piece
1 - 1/4"

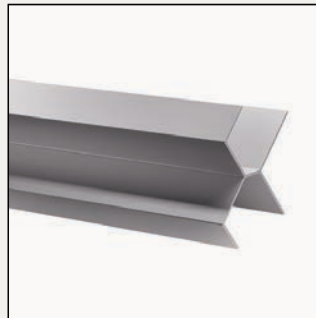

X Corner 1 - 1/4"



Inside Corner 1 - 1/4"

Please Contact Ceraclad Team for More Information at technical@ceraclad.com

PANEL ORIENTATION

CERACLAD siding panels are designed to allow both horizontal and vertical application, providing greater design flexibility for architects. Installers will find that the innovative panel clip system makes installation easy and straightforward no matter which application is chosen.

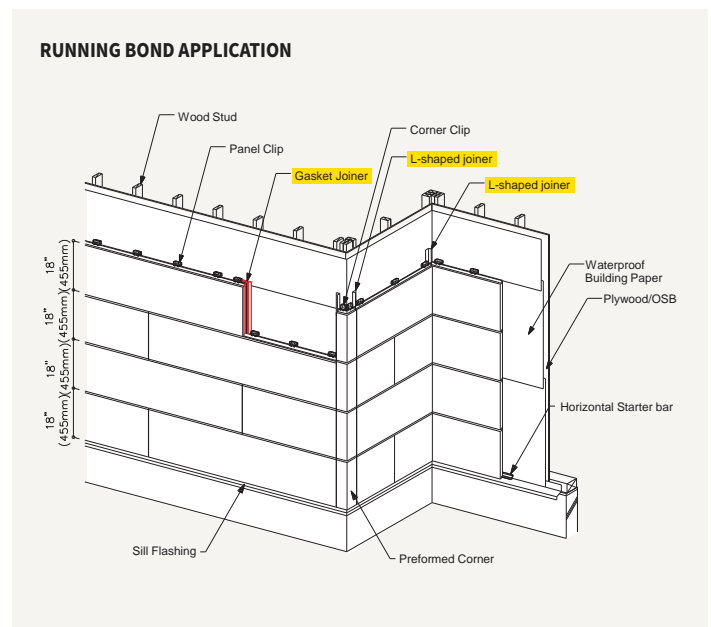
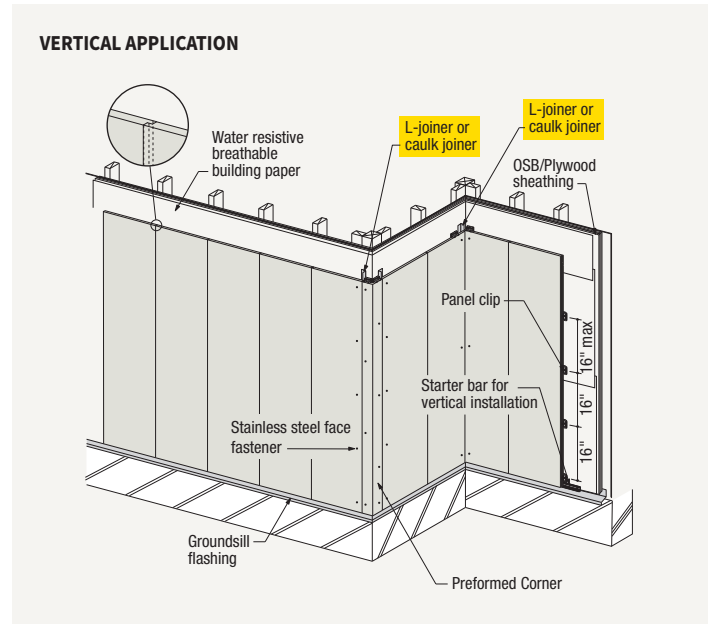
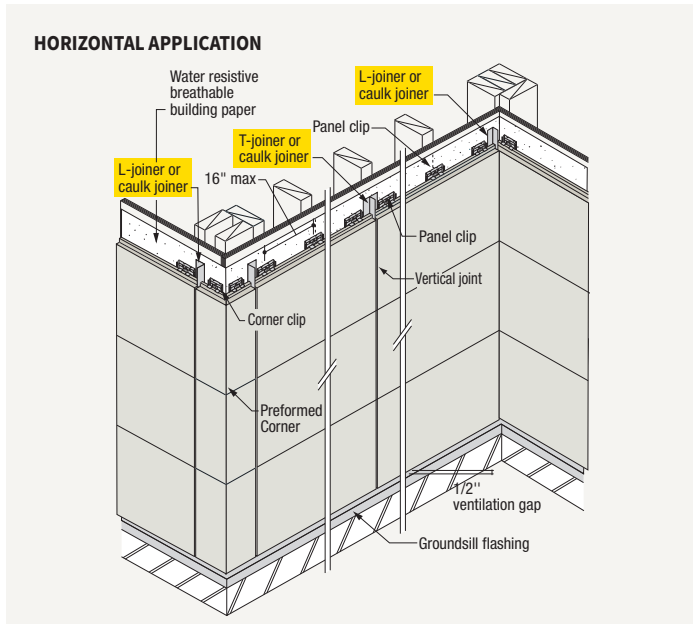



Efficient Layout Examples

10' Horizontal Panel Layout

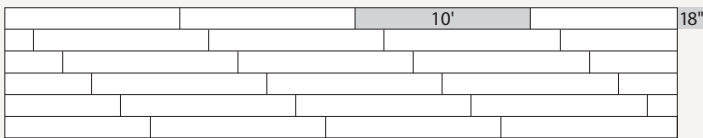

9' x 3' Horizontal Panel Layout

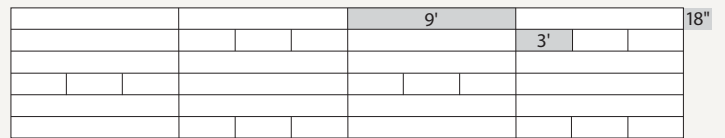

5' Horizontal Panel Layout

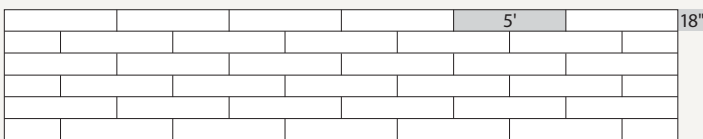

9' Horizontal Panel Band 18" Horizontal Panel Layout

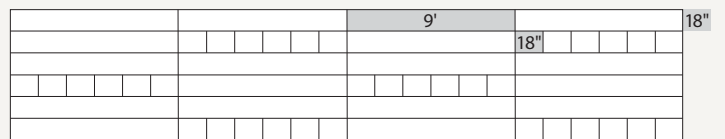

10' Horizontal Panel, 5' Horizontal Panel Layout

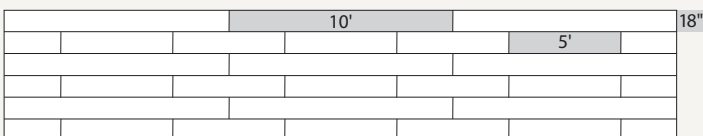



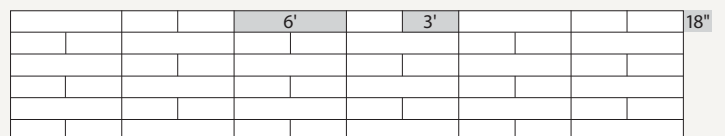



6' x 3' Horizontal Panel Layout



Panel Replacement

REPLACING PANELS

CERACLAD siding panels are designed to allow both horizontal and vertical replacements to be possible. Follow the steps below for an easy understanding and what you will need.

NEEDED TOOLS				
Face Screws	Touch-up Paint	Spacer Block	Putty and putty knife	Waterproof Sealer
				
Full Panel				
Order new panel from factory for replacement				

Replacing a Damaged Panel



- Break and remove damaged panel



- Cut lap joint off new panel and set spacer blocks



- Slip the new panel into place and face fasten panel
- Putty the screws and use touch-up paint to cover

YOUR NEW PANEL MATCHES THE EXISTING COLOR THANKS TO OUR 20 YEAR COLOR ANTI-FADE WARRANTY

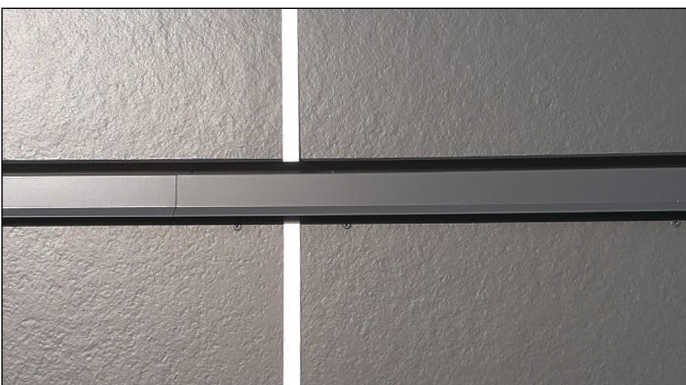
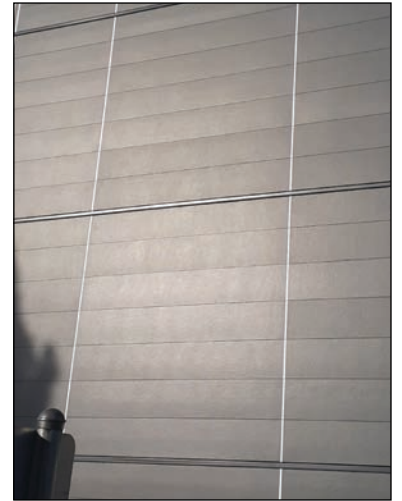

Architectural Details of BluCurrent Bank

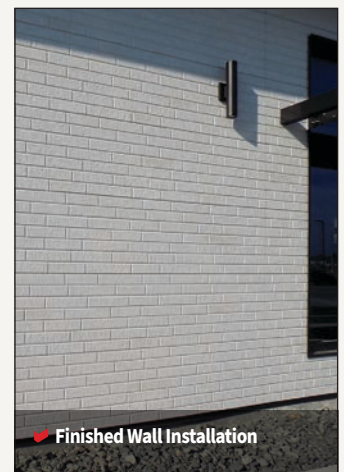
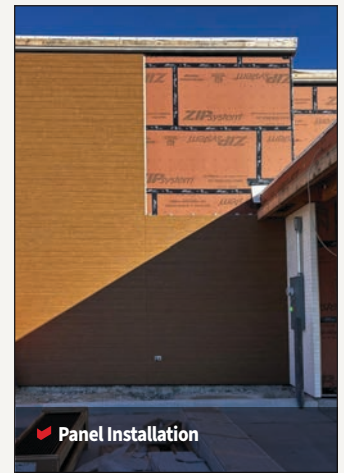

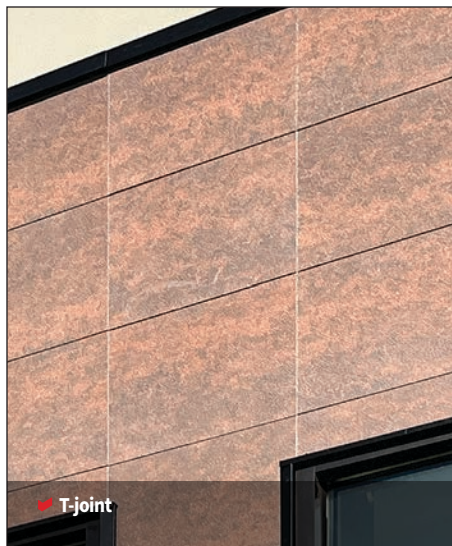
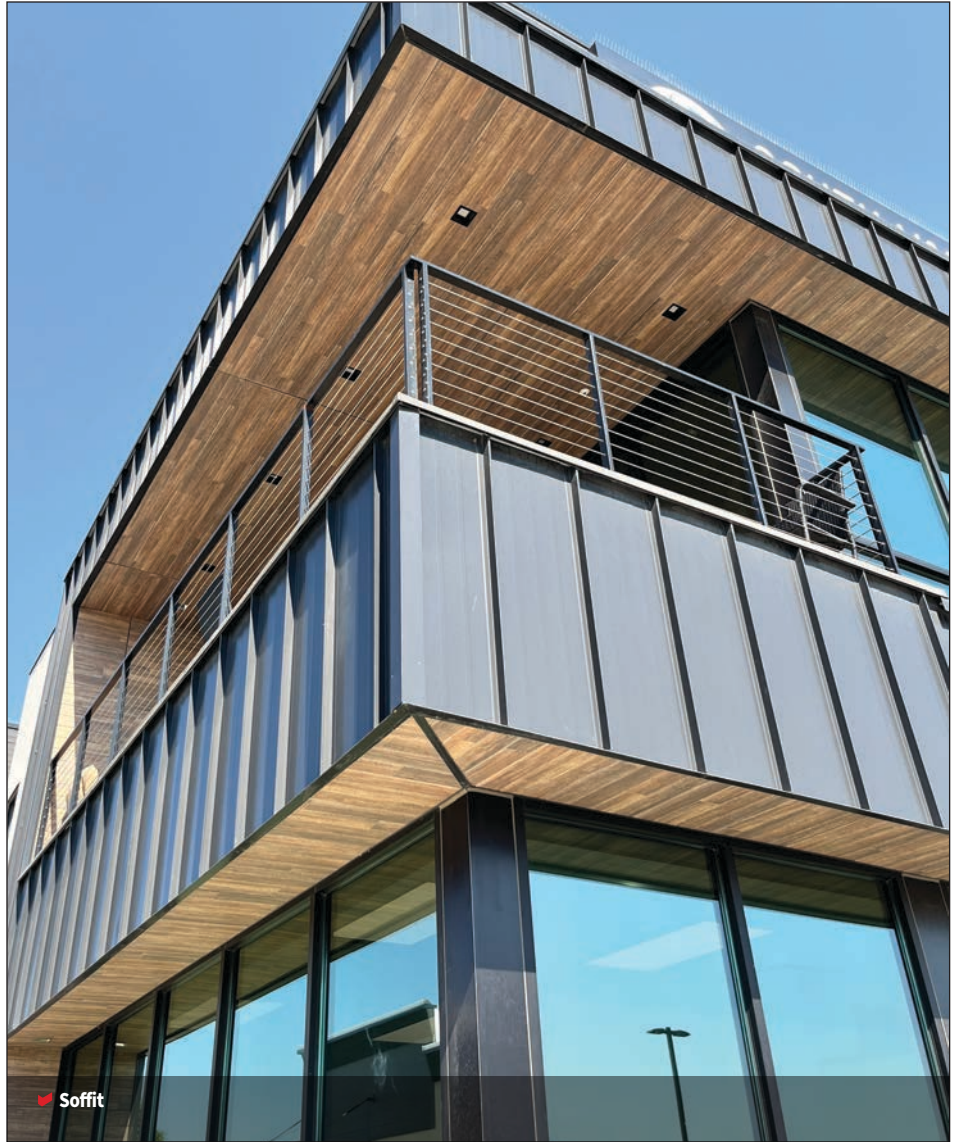
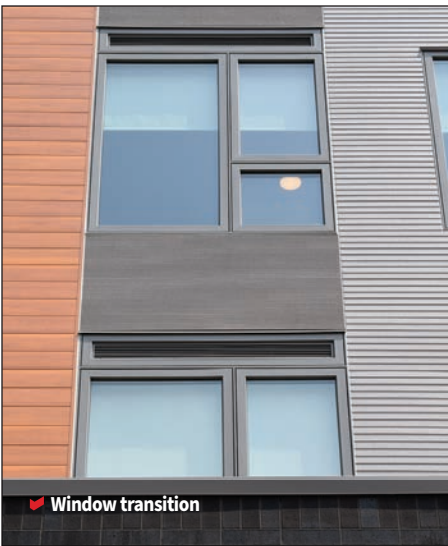
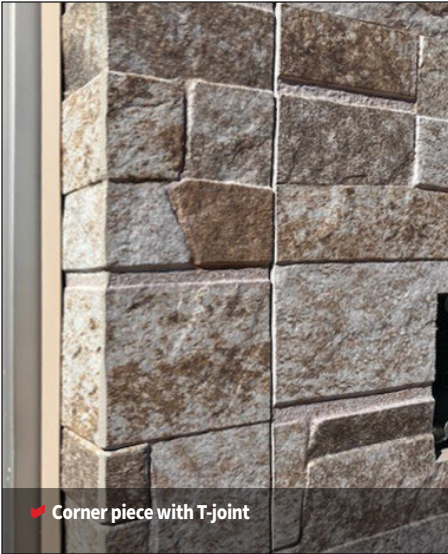

Installation Components Photo Examples

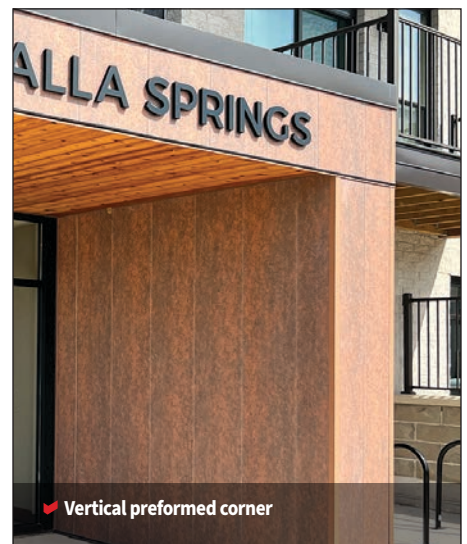
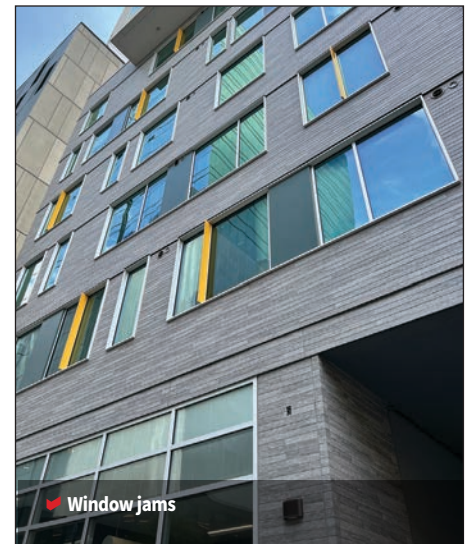
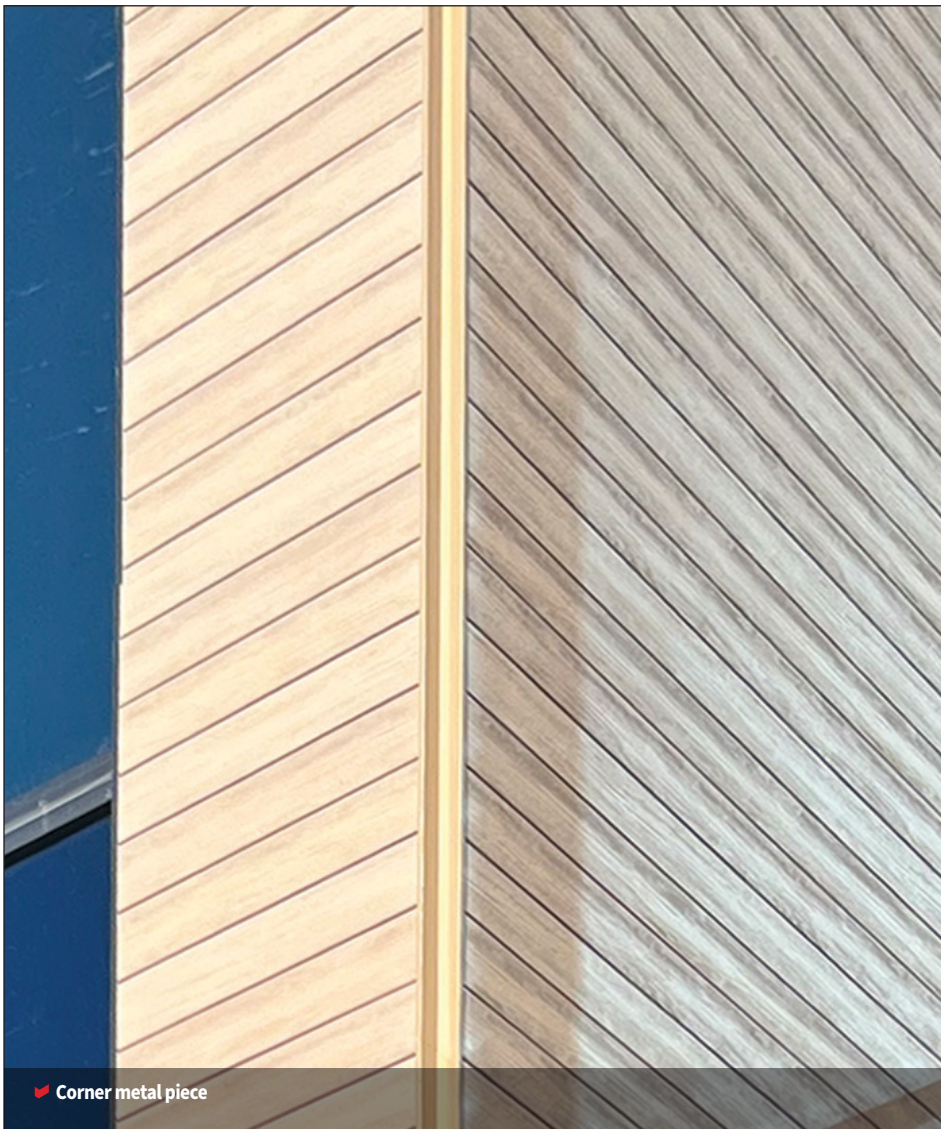

Fire and Wind Certification

SUMMARY OF TEST METHODS

US

ASTME84
 ASTME119
 NFPA285
 NFPA268

Canada

ULC- S101
 ULC-S114
 ULC-S135

FIRE RESISTANCE CHARACTERISTICS

CERA CLAD panels have a Class 1 (A) Flame Spread Classification-0, Smoke Developed Classification-0 when tested in accordance with ASTM E84. Panels are Non-Combustible when tested in accordance with the Canadian Standard CAN ULC S114. CERA CLAD has a tested wall assembly in compliance with the NFPA 285 standard, as well as an engineering judgment to allow polyisocyanurate exterior insulation and FRT wood framing as an equal alternate.

ASSEMBLY WIND RESISTANCE

ASTM E330 Standard Test Methods for determining structural performance of panels under uniform static air pressure difference. Strength Design values for transverse loads are available for the following combinations of wall assembly and CERA CLAD assembly. Additional wind tested assemblies along with a full code compliance report from ICC can be found in ESR 1627.

CERA CLAD Panel Extruded		
Wall Assembly	CERA CLAD Assembly	Strength Design for Positive and Negative Transverse Loads
2x6 wood stud framing 16" o.c. with 1/2" plywood sheathing	Horizontal application 1-3/8" No. 8 screw per clip, clip placed 16" o.c. attached through plywood sheathing to wood stud	47 psf
3-5/8" x 1-5/8" 18GA steel studs spaced 16" o.c., min yield strength 33ksi, 5/8" DensGlass Gold Sheathing	Horizontal application – Full length clip attached to steel studs with one (1) No. 8 stainless steel sheet metal screw placed every 16 inches (maximum) on center	67 psf
18GA Steel Hat channel 17-7/8" o.c. attached to 18GA steel studs	Horizontal applications 3/4" No. 8 screws 2 per clip, clip placed 16" o.c. attached to steal hat channel	41 psf
18GA Steel Hat channel 16" o.c. attached to 18GA steel studs	Vertical applications 3/4" No. 8 screws 2 per clip, clip placed 16" o.c. attached to steal hat channel	38 psf

For SI: 1 inch=25.4mm, 1 foot=305mm, 1 PSF=47.88PA, 1 KSI=6.9,PA. For the latest performance values, please check the website at <https://ceraclad.com>.



KMEW USA - OUR HERITAGE

KMEW was created as a subsidiary joint venture between two Japanese industry titans, **Panasonic** and **Kubota** Corporations. The CERACLAD Rainscreen Fiber Cement Siding System has a proven track record of performance nearing 40 years in Japan. Extensive research and technological advancement led to the development of the company's proprietary **Photocatalytic Ceramic Coating** which provides superior color retention and self-cleaning performance which eliminate costly maintenance.



Both photocatalytic and ceramic coating are applied at one of our factories in Japan to ensure consistent quality and improvement of our product.

OUR HISTORY

With our modest beginnings in North America in 2002, we began our journey providing attractive, high performance cladding systems designed for better living with a multifamily renovation in West Seattle. This first project introduced our cladding solution to the Pacific Northwest and still stands today as a testament to the superior quality and performance of the CERACLAD Rain Screen Cladding System.

Over the next 15 years, the CERACLAD brand grew into the market leading option for factory finished high performance fiber cement cladding. In the Spring of 2017, **KMEW USA Inc.** was formed and the CERACLAD cladding solution was introduced to the full North American market.

KMEW History of Technological Innovation

1989

Established basic technologies of ceramic coating

1999

Released ceramic coating to the market

2002

Released photocatalytic coating to the market

2009

Released photocatalytic ceramic coating with super hydrophilic property to the market

2017

Further evolved performance of photocatalytic ceramic coating

2022

Improved base materials and developed T-Joint Caulk Free System

CERACLAD Framework Toward Sustainable Growth

Every building has its own distinct design, and not all are bound by the same standards. Factors such as regional climate, cultural influences, economic considerations, and social priorities all shape the approach to green building. Sustainability has become a key benchmark for designers across various sectors, including offices, schools, hospitals, and residential spaces. While there are many elements that contribute to a “Green” building, we will highlight three that we believe are the most essential.

KMEW’S GREEN VISION ON TRACK TO NET ZERO

KMEW Japan is committed to reducing our product’s net carbon emissions by 50% by 2030 and achieving net zero by 2050. KMEW USA/CERACLAD received our EPD Certificate in the Spring of 2024.

For Scope 1 and Scope 2, we will advance energy-saving initiatives across our factories and offices, including evaluating production processes to incorporate decarbonized energy.

Scope 3 will prioritize minimizing waste and disposal at job sites while developing low-carbon raw materials and products.

Lastly, KMEW Japan will focus on optimizing our logistics network to reduce emissions related to transportation, considering the distance to each site.

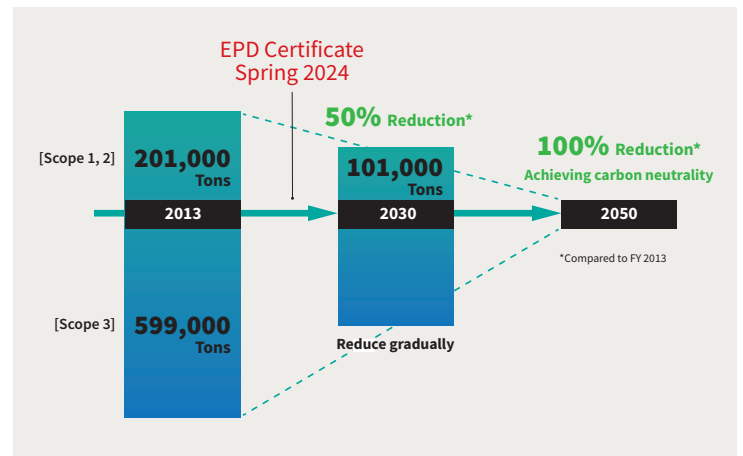

GREEN & RECYCLED MATERIAL

Our products consist of approximately 45% recycled material, the panels are 100% recyclable, factory finished with no VOC, and contain no asbestos. Fly ash and pulp are included as recycled materials, reducing resource consumption during production. In our manufacturing process, all discharged water is treated by the latest treatment technologies and recycled as much as possible.



LEED certified projects
 HPD (Health Product Declaration) certified material



PRODUCT PROMISE

CERACLAD employs an advanced Triple Coated process in the manufacturing of our panels. This exceptional process grants our products a comprehensive warranty package, including a 20-year anti-fade warranty and an impressive 30-year product warranty. The ceramic seal, a key component of this process, acts as a robust shield against color fading caused by UV light exposure. Additionally, our final photocatalytic seal serves as a stalwart defender against dirt and grime adhesion to our panels. Working in synergy with UV rays and rain, this seal effectively dislodges and removes accumulated debris, ensuring that our panels maintain their pristine appearance, just as they did on the day of application.



Zen Garden - Silk, Wheat, CREATIV

CERA CLAD® Triple Coated
Fiber-Cement Caulk-Free
Siding Rainscreen System

20-Year Fade Limited Warranty • 365 Days Self Cleaning • Low Maintenance

Please visit our website for additional **CERA CLAD** product information including:

- ✓ Product samples
- ✓ Custom color samples
- ✓ REVIT downloads
- ✓ CAD details
- ✓ Specifications
- ✓ Product performance and approval documents
- ✓ MSDS

MANUFACTURED BY:
KMEW Co., Ltd.
13F, Crystal Tower Bldg.
1-2-27 Shiromi, Chuo-Ku,
Osaka 540-6013
Japan

REPRESENTED BY:
KMEW USA | CERA CLAD
8461 154th Avenue NE
Building G, Suite 100
Redmond, WA 98052
USA

